

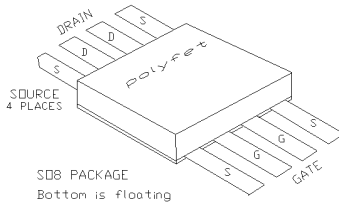

General Description

Silicon VDMOS and LDMOS transistors designed specifically for broadband RF applications. Suitable for Military Radios, Cellular and Paging Amplifier Base Stations, Broadcast FM/AM, MRI, Laser Driver and others.

"Polyfet"TM process features low feedback and output capacitances, resulting in high F_T transistors with high input impedance and high efficiency.



SILICON GATE ENHANCEMENT MODE

RF POWER VDMOS TRANSISTOR

8.0 Watts Single Ended

Package Style SO8

HIGH EFFICIENCY, LINEAR

HIGH GAIN, LOW NOISE

ROHS COMPLIANT

ABSOLUTE MAXIMUM RATINGS (T = 25 °C)

Total Device Dissipation	Junction to Case Thermal Resistance	Maximum Junction Temperature	Storage Temperature	DC Drain Current	Drain to Gate Voltage	Drain to Source Voltage	Gate to Source Voltage
30 Watts	7.00 °C/W	200 °C	-65 °C to 150 °C	1.8 A	70 V	70 V	20 V

RF CHARACTERISTICS (8.0 WATTS OUTPUT)

SYMBOL	PARAMETER	MIN	TYP	MAX	UNITS	TEST CONDITIONS
Gps	Common Source Power Gain	10			dB	Idq = 0.40 A, Vds = 28.0 V, F =1,000 MHz
η	Drain Efficiency		45		%	Idq = 0.40 A, Vds = 28.0 V, F =1,000 MHz
VSWR	Load Mismatch Tolerance			20:1	Relative	Idq = 0.40 A, Vds = 28.0 V, F =1,000 MHz

ELECTRICAL CHARACTERISTICS (EACH SIDE)

SYMBOL	PARAMETER	MIN	TYP	MAX	UNITS	TEST CONDITIONS
Bvdss	Drain Breakdown Voltage	65			V	Ids = 20.00 mA, Vgs = 0V
Idss	Zero Bias Drain Current			0.4	mA	Vds = 28.0 V, Vgs = 0V
Igss	Gate Leakage Current			1	uA	Vds = 0V Vgs = 30V
Vgs	Gate Bias for Drain Current	2		5	V	Ids = 0.04 A, Vgs = Vds
gM	Forward Transconductance		0.6		Mho	Vds = 10V, Vgs = 5V
Rdson	Saturation Resistance		2.00		Ohm	Vgs = 20V, Ids = 1.00 A
Idsat	Saturation Current		2.80		Amp	Vgs = 20V, Vds = 10V
Ciss	Common Source Input Capacitance		20.0		pF	Vds = 28.0 Vgs = 0V, F = 1 MHz
Crss	Common Source Feedback Capacitance		1.2		pF	Vds = 28.0 Vgs = 0V, F = 1 MHz
Coss	Common Source Output Capacitance		12.0		pF	Vds = 28.0 Vgs = 0V, F = 1 MHz

S8202

POUT VS PIN GRAPH

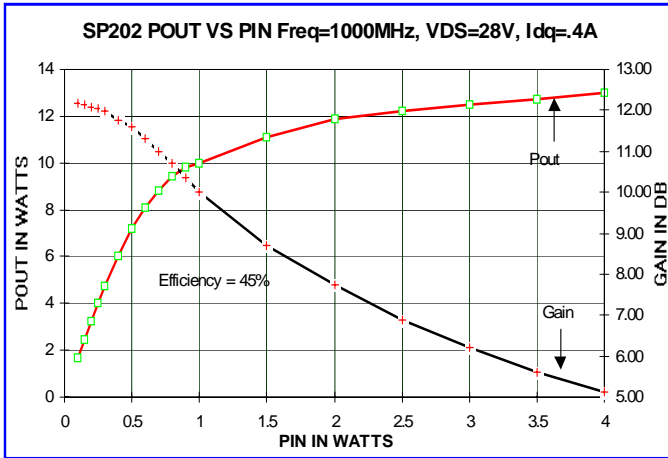

IV CURVE

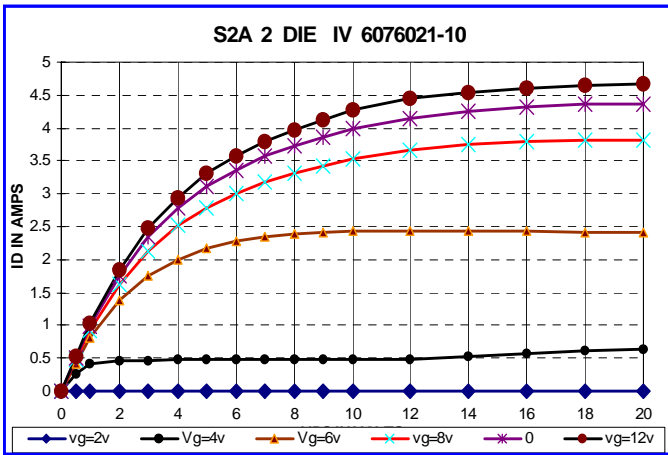

Zin Zout

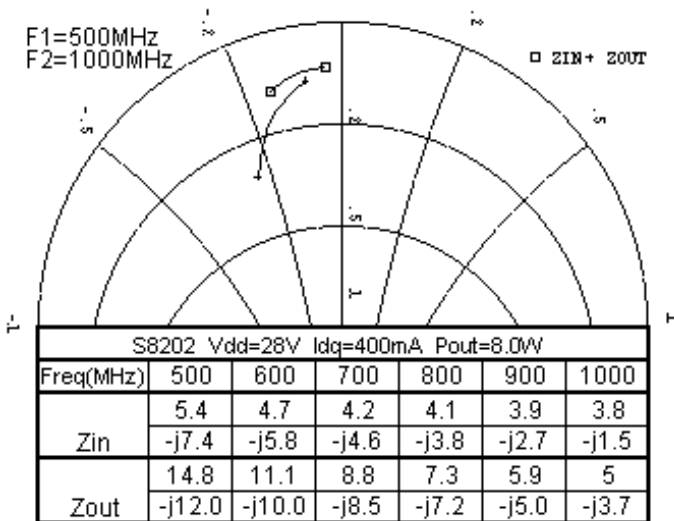

CAPACITANCE VS VOLTAGE

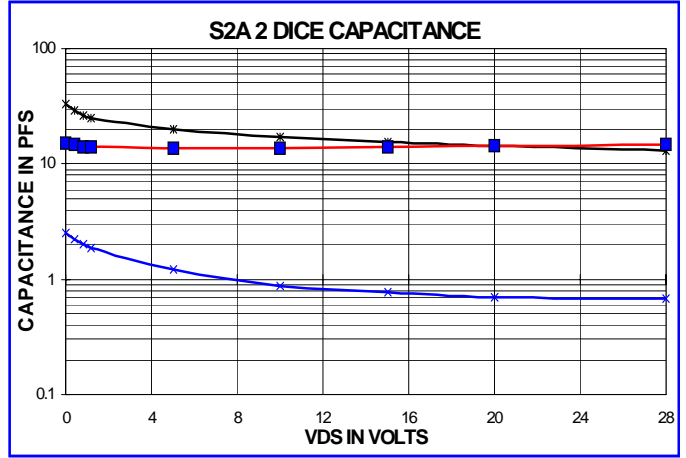

ID & GM VS VGS

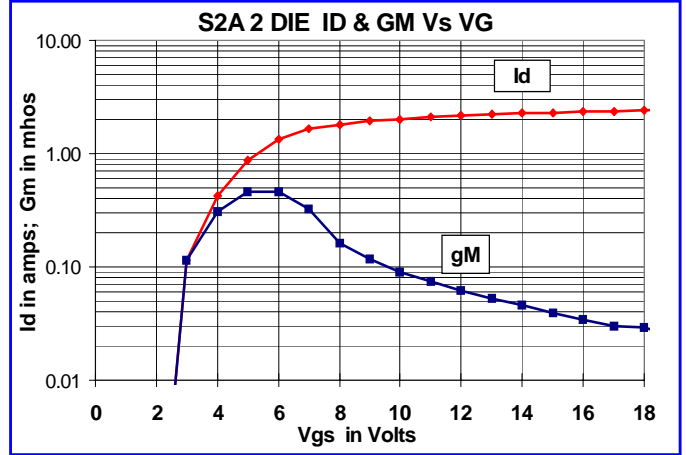

PACKAGE DIMENSIONS IN INCHES

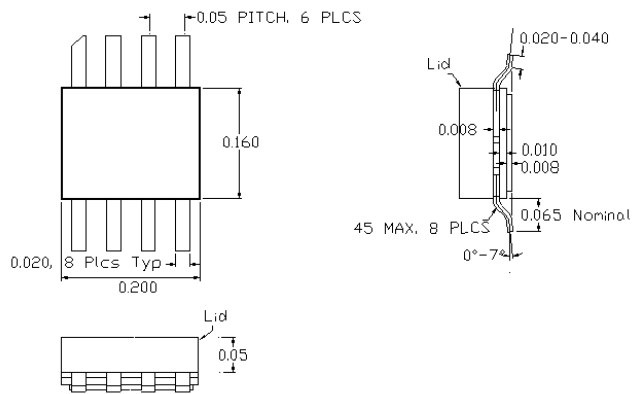

S08 / S08 -1

Tolerance .XX +/-0.01 .XXX +/-0.005 inches