

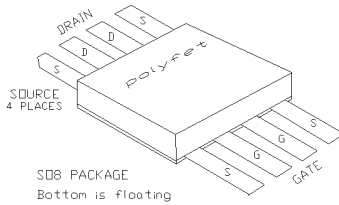

**General Description**

Silicon VDMOS and LDMOS transistors designed specifically for broadband RF applications. Suitable for Military Radios, Cellular and Paging Amplifier Base Stations, Broadcast FM/AM, MRI, Laser Driver and others.

"Polyfet"<sup>TM</sup> process features low feedback and output capacitances, resulting in high  $F_T$  transistors with high input impedance and high efficiency.



**SILICON GATE ENHANCEMENT MODE**

**RF POWER VDMOS TRANSISTOR**

**4.0 Watts Single Ended**

**Package Style SO8**

**HIGH EFFICIENCY, LINEAR**

**HIGH GAIN, LOW NOISE**

**ROHS COMPLIANT**

**ABSOLUTE MAXIMUM RATINGS ( T = 25 °C )**

| Total Device Dissipation | Junction to Case Thermal Resistance | Maximum Junction Temperature | Storage Temperature | DC Drain Current | Drain to Gate Voltage | Drain to Source Voltage | Gate to Source Voltage |
|--------------------------|-------------------------------------|------------------------------|---------------------|------------------|-----------------------|-------------------------|------------------------|
| 20 Watts                 | 10.00 °C/W                          | 200 °C                       | -65 °C to 150 °C    | 1.2 A            | 70 V                  | 70 V                    | 20 V                   |

**RF CHARACTERISTICS ( 4.0 WATTS OUTPUT )**

| SYMBOL | PARAMETER                | MIN | TYP | MAX  | UNITS    | TEST CONDITIONS                          |
|--------|--------------------------|-----|-----|------|----------|--|
| Gps    | Common Source Power Gain | 10  |     |      | dB       | Idq = 0.20 A, Vds = 28.0 V, F =1,000 MHz |
| $\eta$ | Drain Efficiency         |     | 45  |      | %        | Idq = 0.20 A, Vds = 28.0 V, F =1,000 MHz |
| VSWR   | Load Mismatch Tolerance  |     |     | 20:1 | Relative | Idq = 0.20 A, Vds = 28.0 V, F =1,000 MHz |

**ELECTRICAL CHARACTERISTICS ( EACH SIDE )**

| SYMBOL | PARAMETER                          | MIN | TYP  | MAX | UNITS | TEST CONDITIONS                |
|--------|------------------------------------|-----|------|-----|-------|--------------------------------|
| Bvdss  | Drain Breakdown Voltage            | 65  |      |     | V     | Ids = 10.00 mA, Vgs = 0V       |
| Idss   | Zero Bias Drain Current            |     |      | 0.2 | mA    | Vds = 28.0 V, Vgs = 0V         |
| Igss   | Gate Leakage Current               |     |      | 1   | uA    | Vds = 0V Vgs = 30V             |
| Vgs    | Gate Bias for Drain Current        | 2   |      | 5   | V     | Ids = 0.02 A, Vgs = Vds        |
| gM     | Forward Transconductance           |     | 0.3  |     | Mho   | Vds = 10V, Vgs = 5V            |
| Rdson  | Saturation Resistance              |     | 4.00 |     | Ohm   | Vgs = 20V, Ids = 0.50 A        |
| Idsat  | Saturation Current                 |     | 1.40 |     | Amp   | Vgs = 20V, Vds = 10V           |
| Ciss   | Common Source Input Capacitance    |     | 10.0 |     | pF    | Vds = 28.0 Vgs = 0V, F = 1 MHz |
| Crss   | Common Source Feedback Capacitance |     | 0.6  |     | pF    | Vds = 28.0 Vgs = 0V, F = 1 MHz |
| Coss   | Common Source Output Capacitance   |     | 6.0  |     | pF    | Vds = 28.0 Vgs = 0V, F = 1 MHz |

# S8201

POUT VS PIN GRAPH

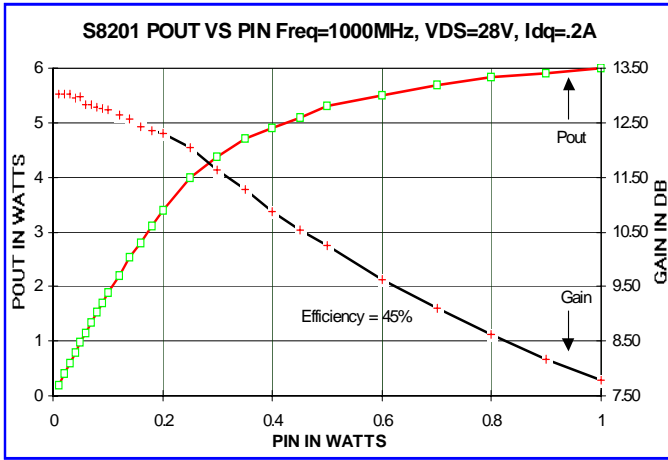

IV CURVE

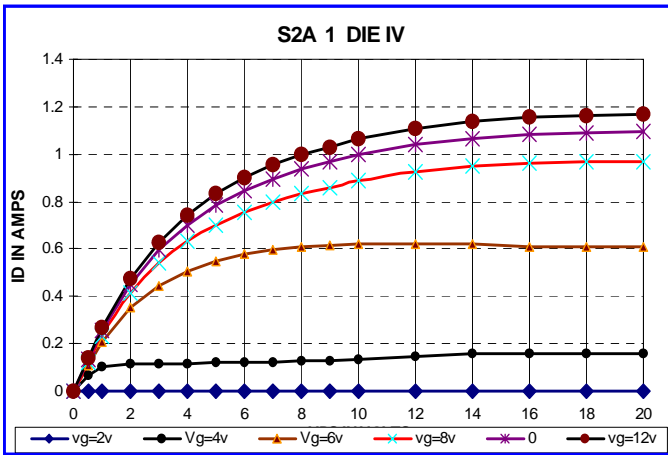

Zin Zout

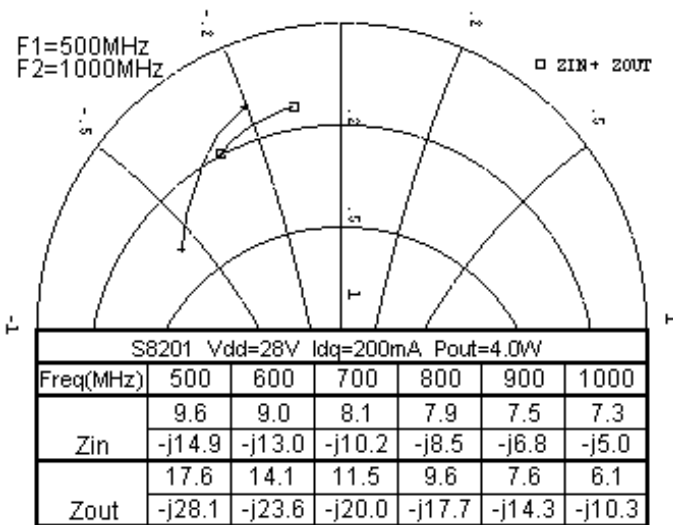

CAPACITANCE VS VOLTAGE

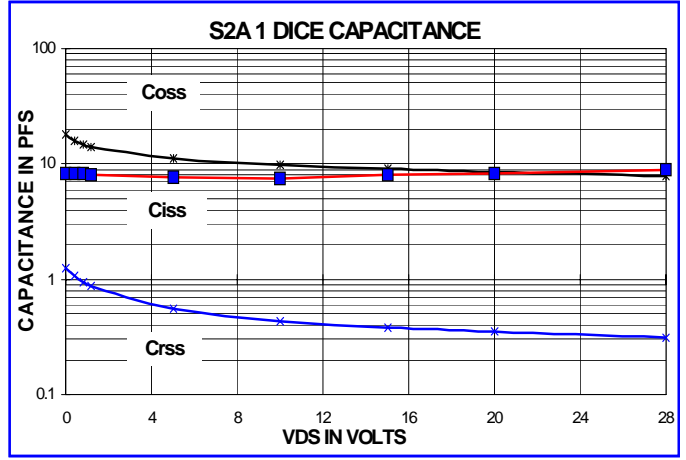

ID & GM VS VGS

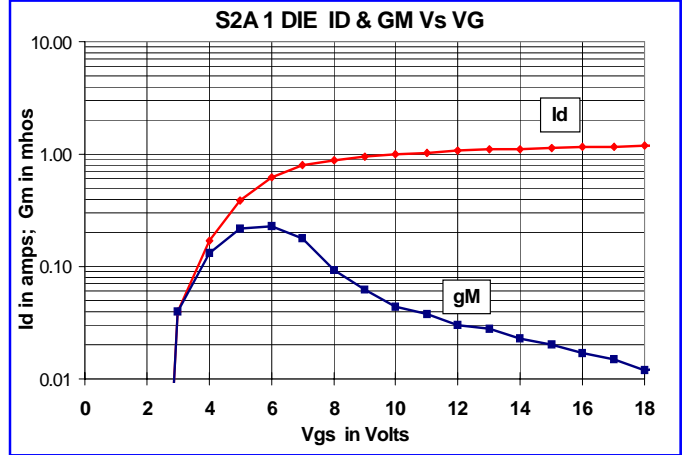

PACKAGE DIMENSIONS IN INCHES

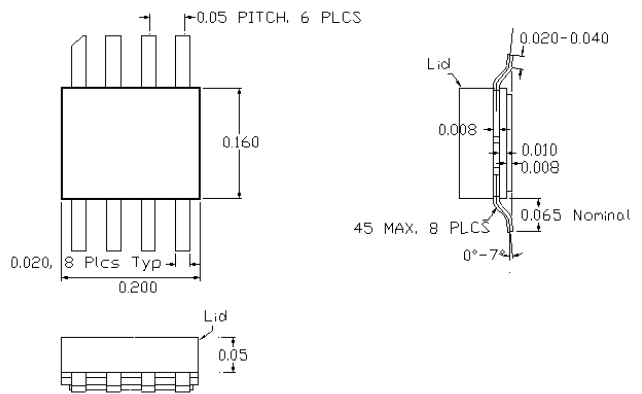

S08 / S08 -1

Tolerance .XX +/-0.01 .XXX +/- .005 inches