

TB219#3

Frequency=30-512MHz

Pout=20W

Gain=12dB

Vds=28Vdc

Idq=200mA

Efficiency=35-40%

LQ801



TB219#3 Gain/Efficiency vs Frequency: Vds=28Vdc, Idq=200mA, Pout=20W

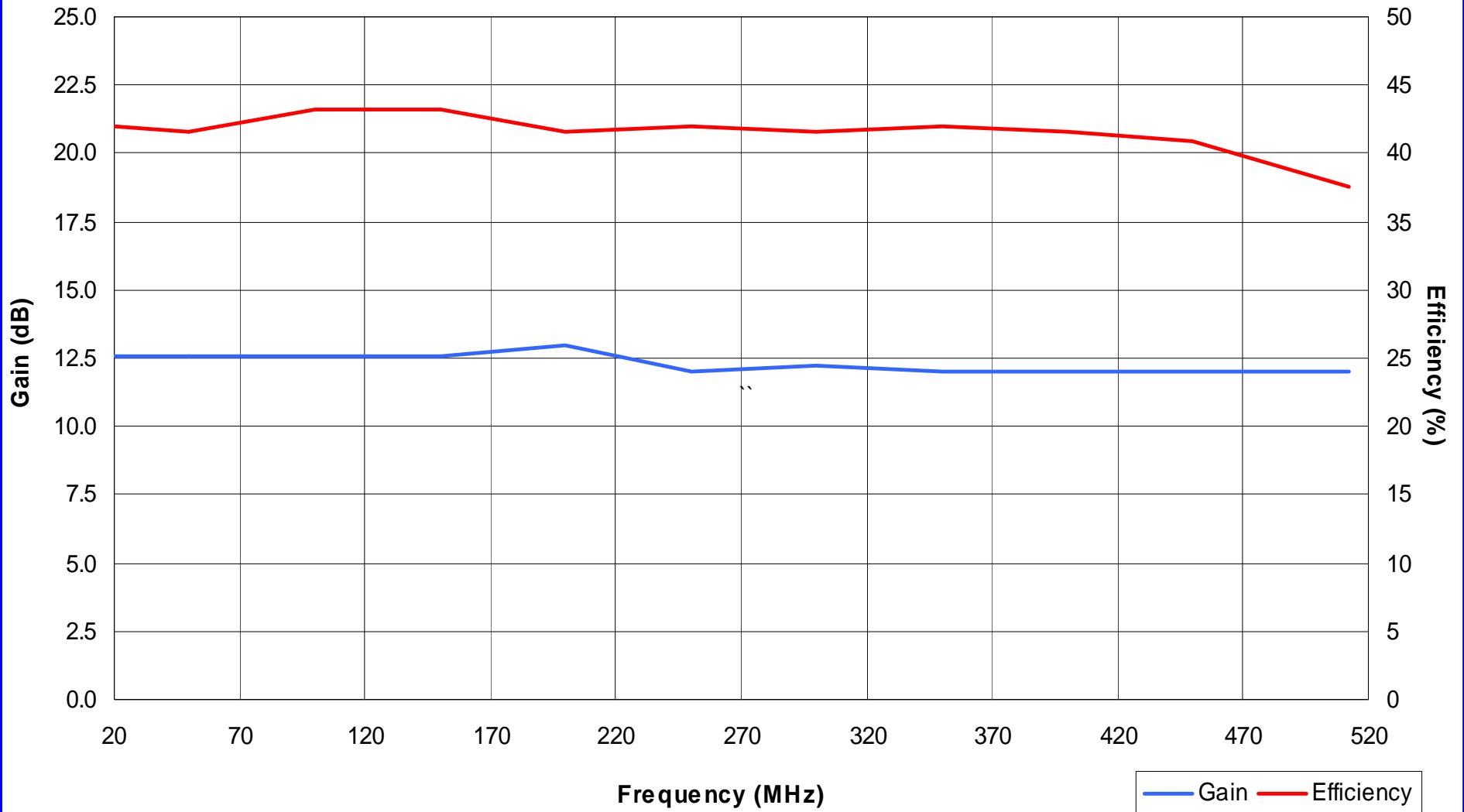

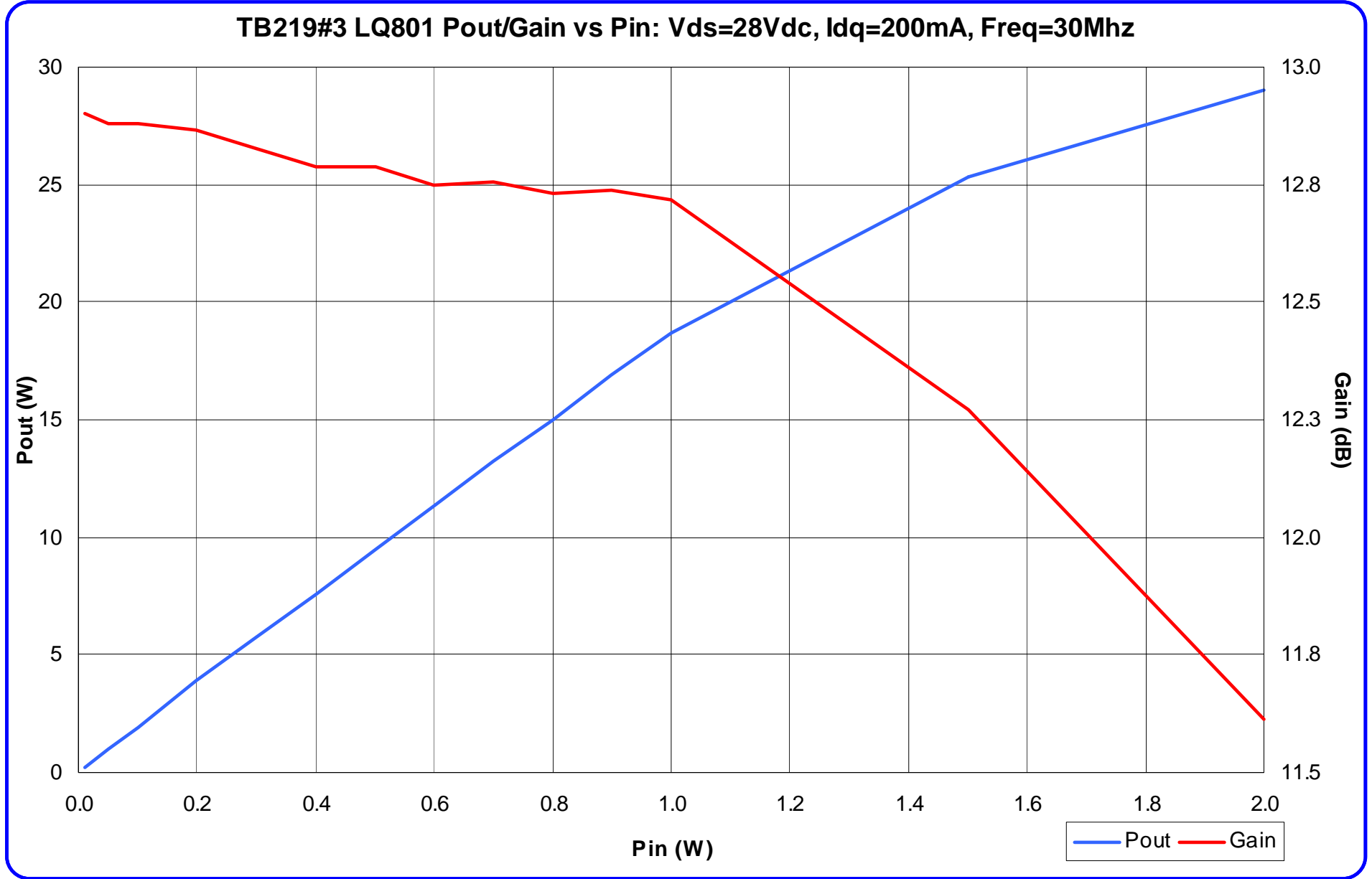

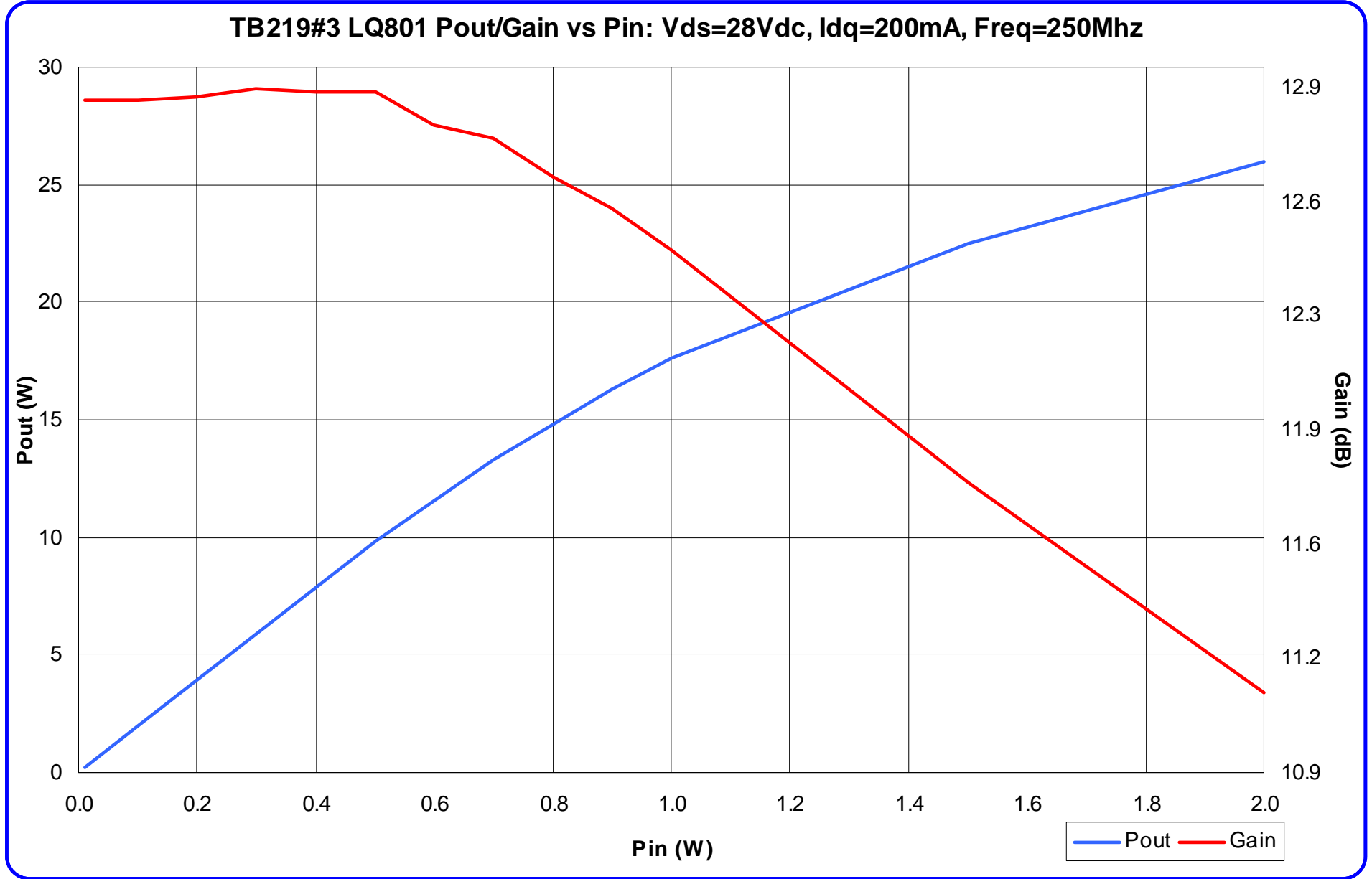

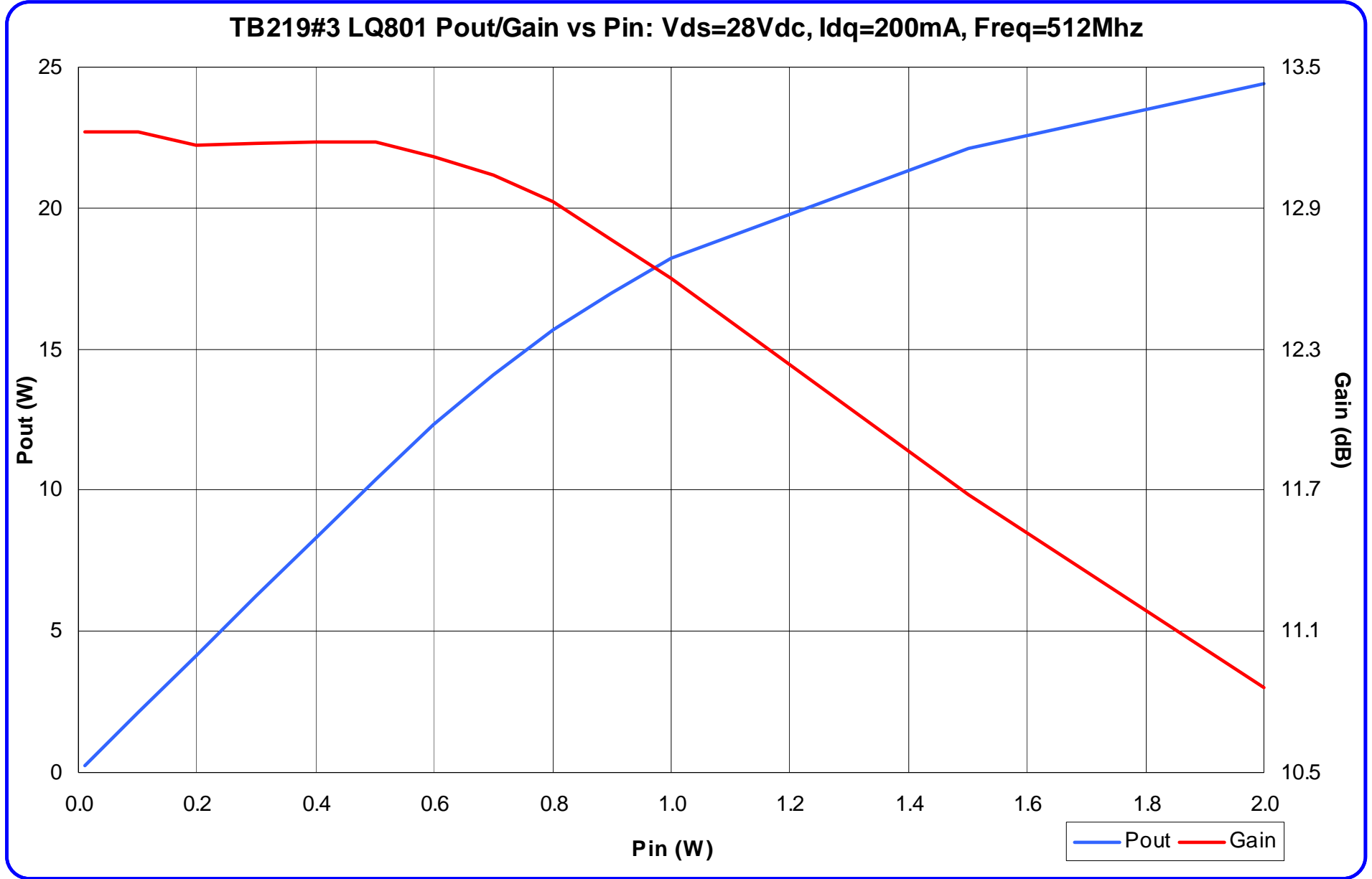

TB219#3 LQ801 P1dB vs Frequency: Vds=28Vdc, Idq=200mA

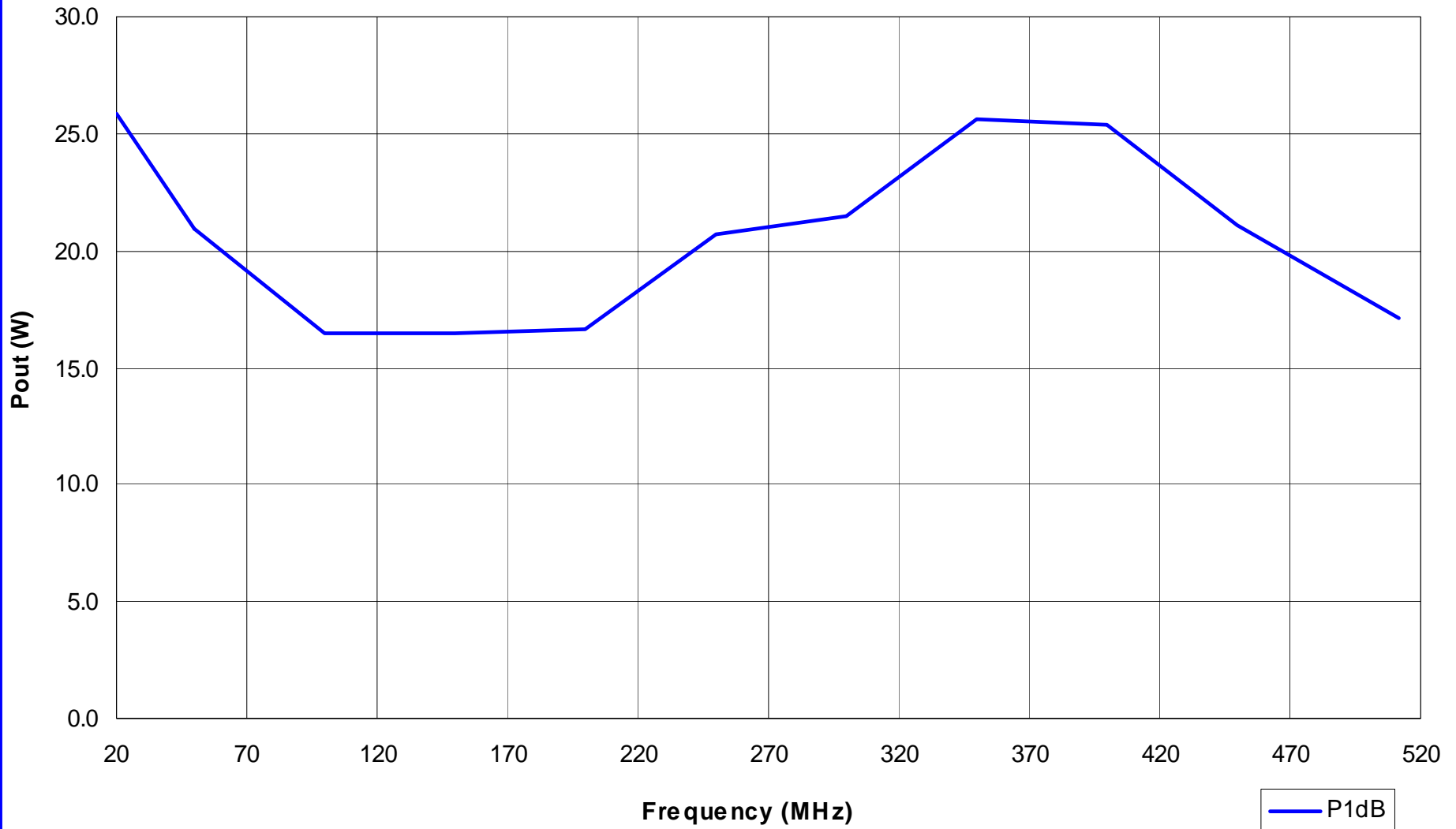

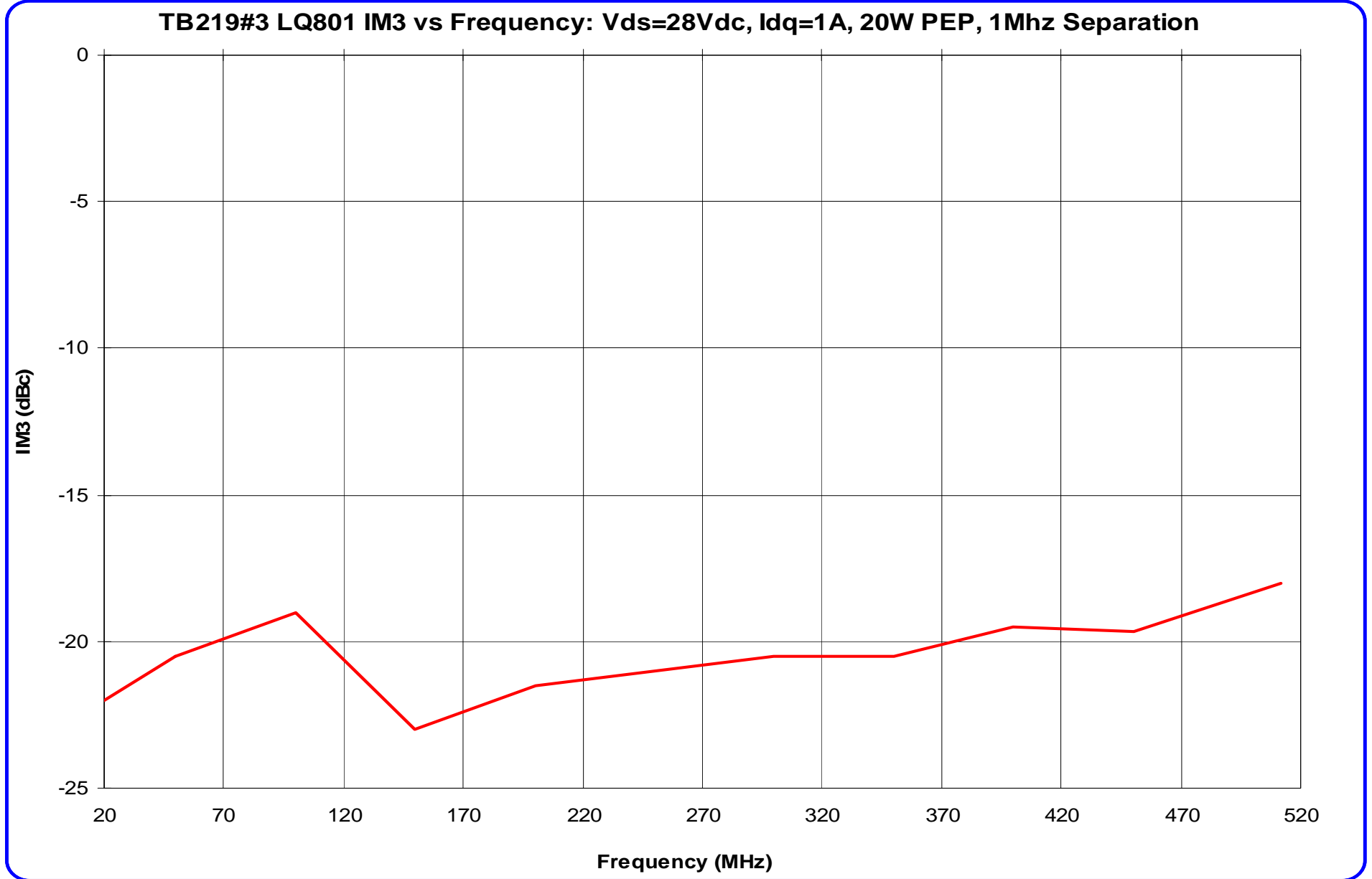

TB219#3 LQ801 Harmonics vs Frequency: Vds=28Vdc, Idq=200mA, Pout=20W

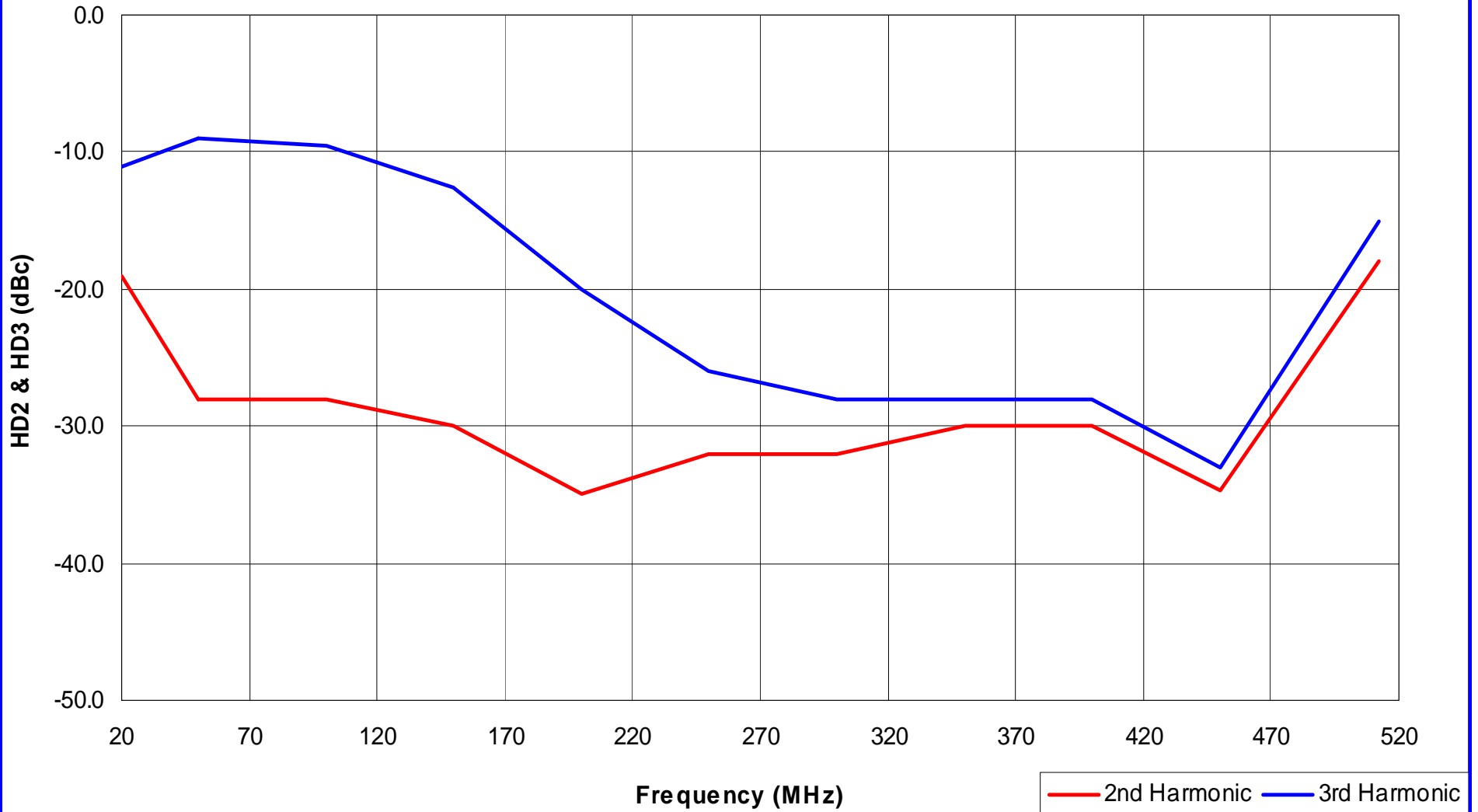

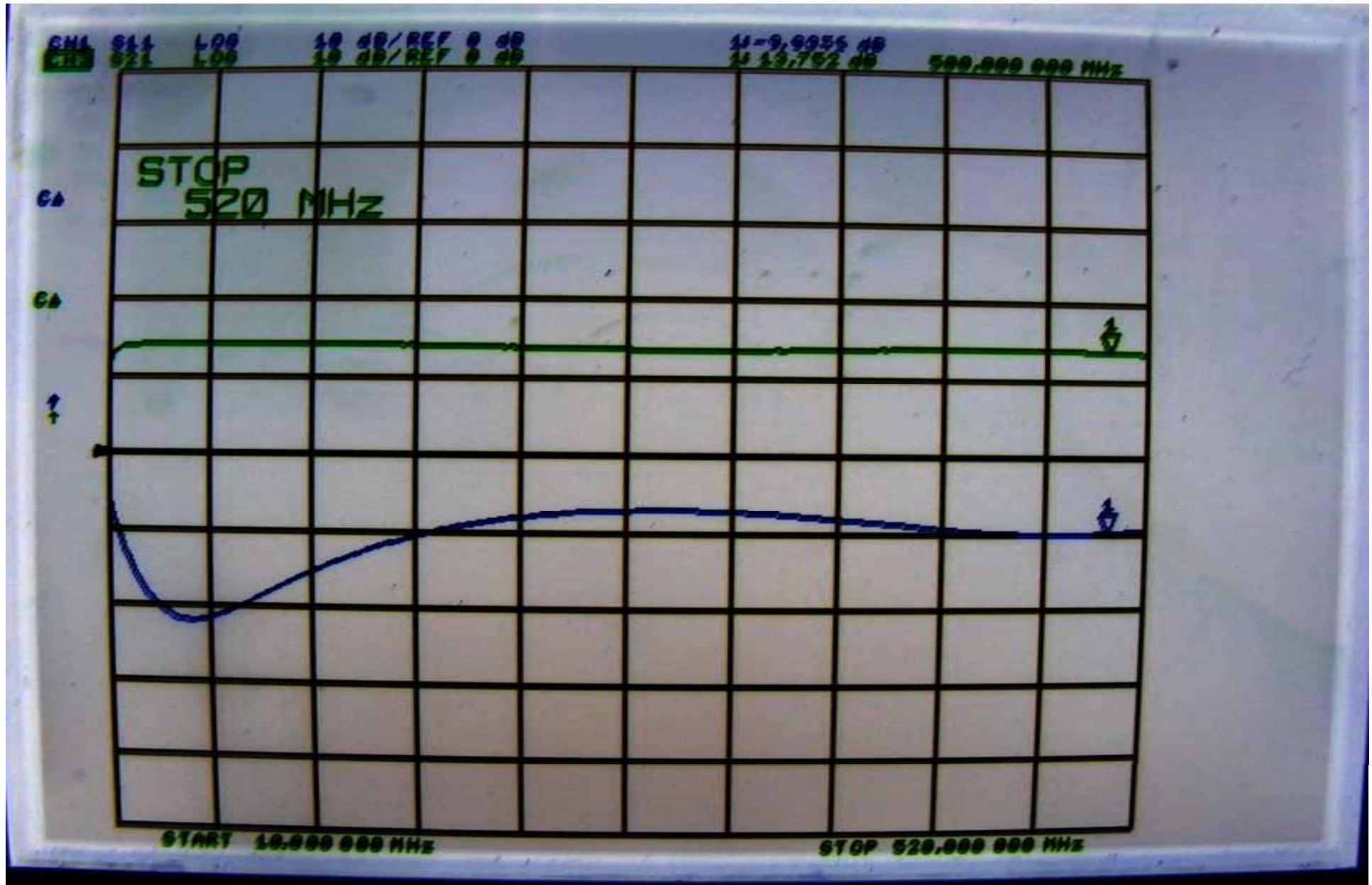

TB219#3 Vds=28Vdc, Idq=200mA, Pin=0dBm

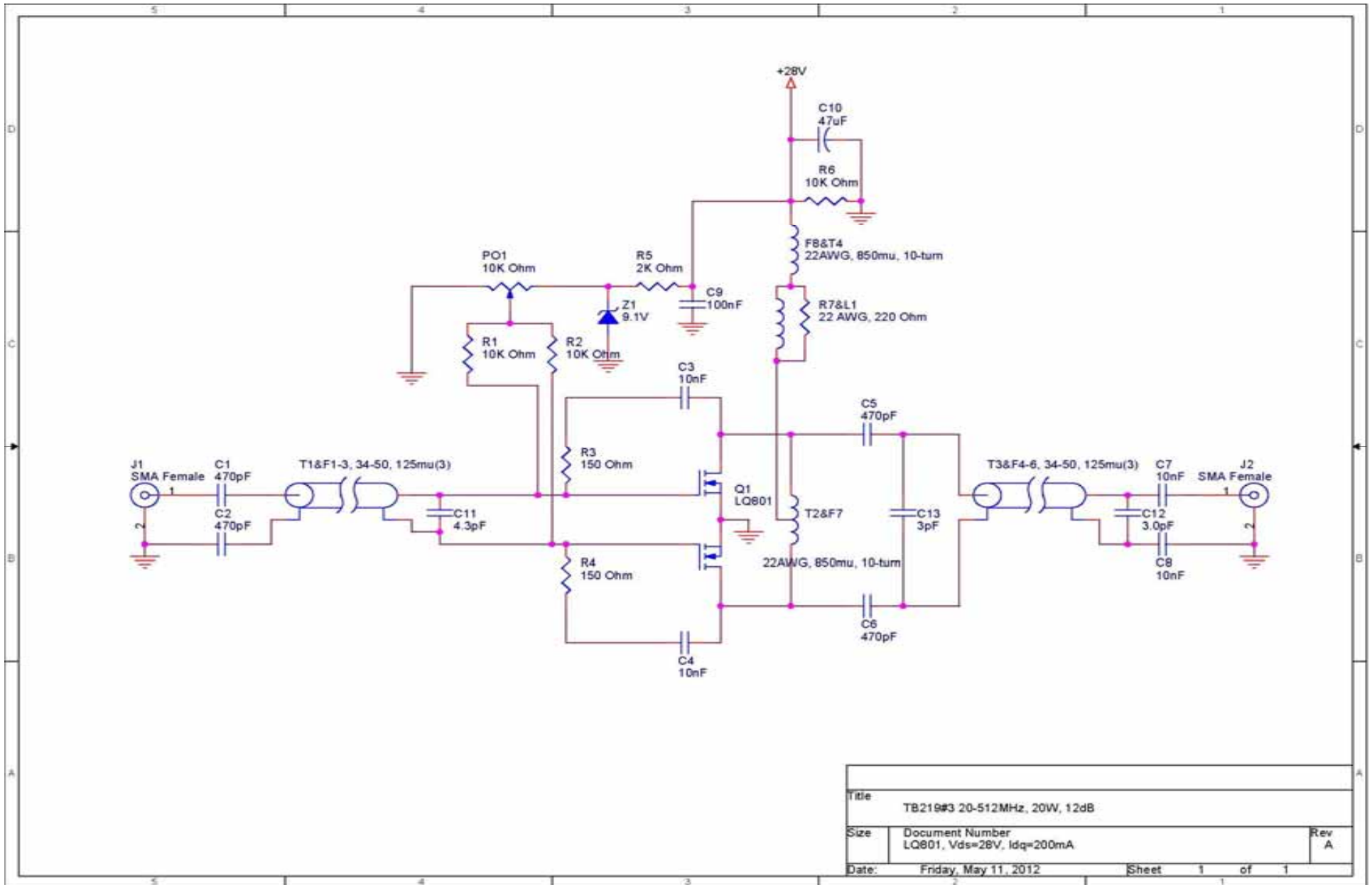

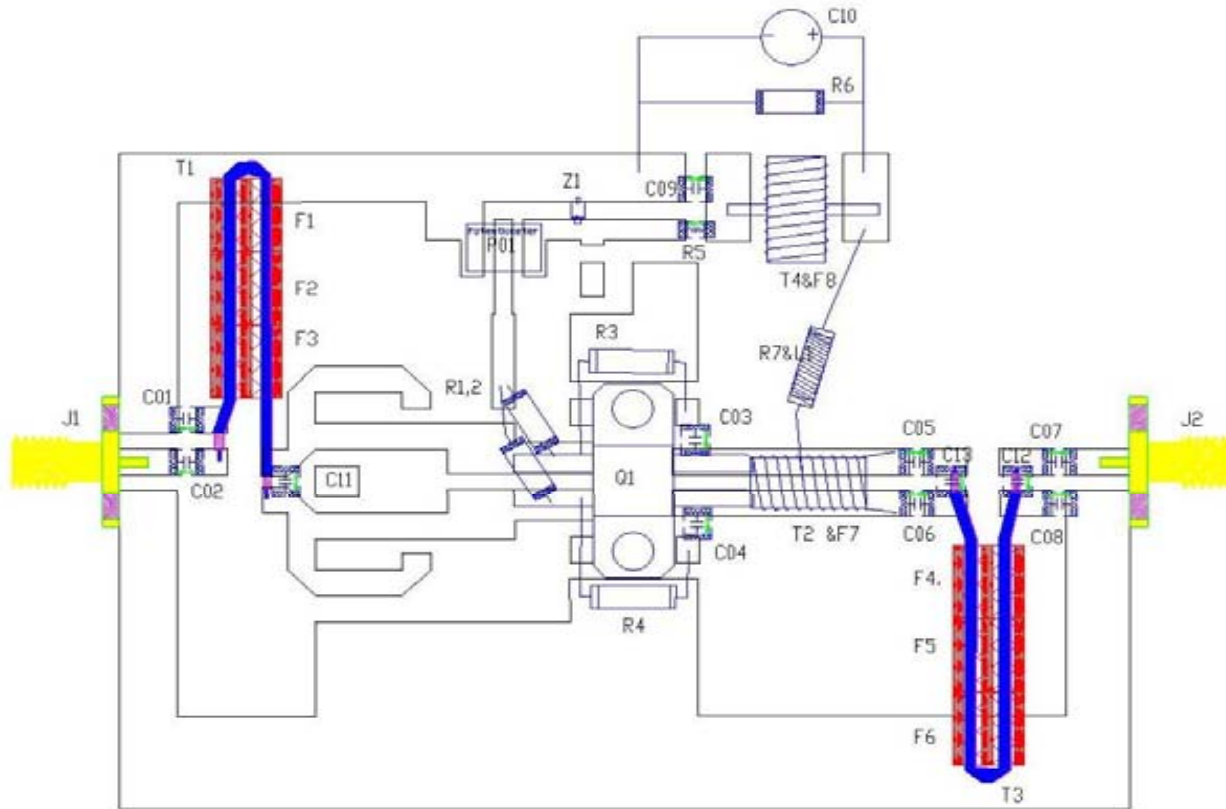

BRN Edwin Cunningham	5/11/12	POLYFET RF DEVICES		
DRKD :		30-512Mhz, 20W, 12dB		
ELECT-Marcos Cervantes	5/11/12	SIZE	FSCM NO	REV
MECH-Marcos Cervantes	5/11/12			0
PROC :		TB219 LAYOUT		
QUAL :		SCALE : 1 : 1	SHEET 1 OF 1	
PGMS :				

NOMENCLATURE	DESCRIPTION	VENDER	VENDER PART #
C1,C2,C5,C6	470pF Porcelain Superchip Multilayer Capacitor	ATC	100B471JW50X
C9	100nF Ceramic Multilayer Capacitor	ATC	200B104KW50X
C3,C4,C7,C8	10nF Ceramic Multilayer Capacitor	ATC	200B103KW50X
C11	H-Q/LOW ESR 4.3 PF CAP	Passive Plus, Inc	1111N4R3BW501
C12,C13	H-Q/LOW ESR 3.0 PF CAP	Passive Plus, Inc	1111N3R0BW501
C10	CAPACITOR, RADIAL, 63V, 47UF; Capacitance Tolerance: $\pm 20\%$	DIGI-KEY	P10340-ND
R1,R2,R6	RES 10K OHM 2W 5% METAL FILM AX	DIGI-KEY	10KZTR-ND
R5	RES 2.0K OHM 1/4W 5% 1206 SMD	DIGI-KEY	P2.0KECT-ND
R7	RES 220 OHM 1/2W 5% CARBON FILM	DIGI-KEY	220H-ND
R3,R4	RES 150 OHM 2W 5% METAL OXIDE	DIGI-KEY	RSF200JB-73-150R
L1	22AWG 9 turns around R7	www.electromechanicsonline.com	MW220SPNRD
T1,T3	34MIL 50 OHM SEMIRIGID COAX Total=2 inch	Amawave	UT34-50
T2	Magnet Wire,22AWG, 21-turns around F7	www.electromechanicsonline.com	MW220SPNRD
T4	Magnet Wire,22AWG, 21-turns around F8	www.electromechanicsonline.com	MW220SPNRD
F1,F2,F3,F4,F5,F6	125ui,Toroid	Amidon	BN-61-2402
F7,F8	850ui Toroid	Amidon	FT-50-43
POT1	Trimmer Resistors - 10K OHM 0.25W SMD	Mouser Electronics	490-2661-1-ND
Z1	DIODE ZENER 9.1V 500MW SOD80C	DIGI-KEY	568-6272-1-ND
Q1	LDMOS	Polyfet RF Devices	LQ801
J1,J2	SMA Female; 4 Hole Panel Mount	Pasternack	PE4000-SF
PCB	PTFE/woven glass AD450 Er=4.5 30mil 1oz/1oz copper	Arlon	AD450-0600-C1/C1