

# TB267

## LS2541HF

Frequency = 2-30MHz

Pout = 56.53dBm

Gain (avg) = 26.9dB +/- 0.85dB

Vds = 50VDC

Idq = 1.0A

Efficiency (avg) = 66.8% +/- 2.0%

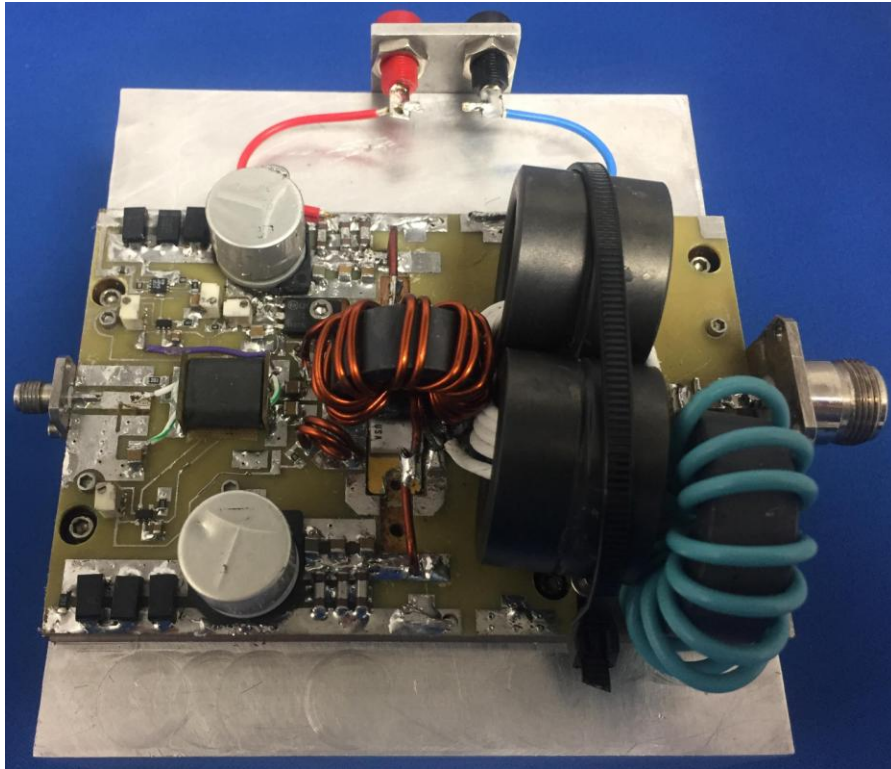

### Order of Operations:

1. Review amplifier's performance curves in the data package to learn its RF power limitations.
2. Terminate the RF In/Out connectors to 50 ohm source and load impedance.
3. Connect Ground and Vds power supply to TB267.
4. Apply Vds voltage and verify Idq is as stated in this data package.
5. Apply RF drive signal (refer to curves in data package to avoid overdrive).
6. Avoid allowing the heat sink to reach 85 deg C. Use of a 55.3CFM fan required for long-term use.

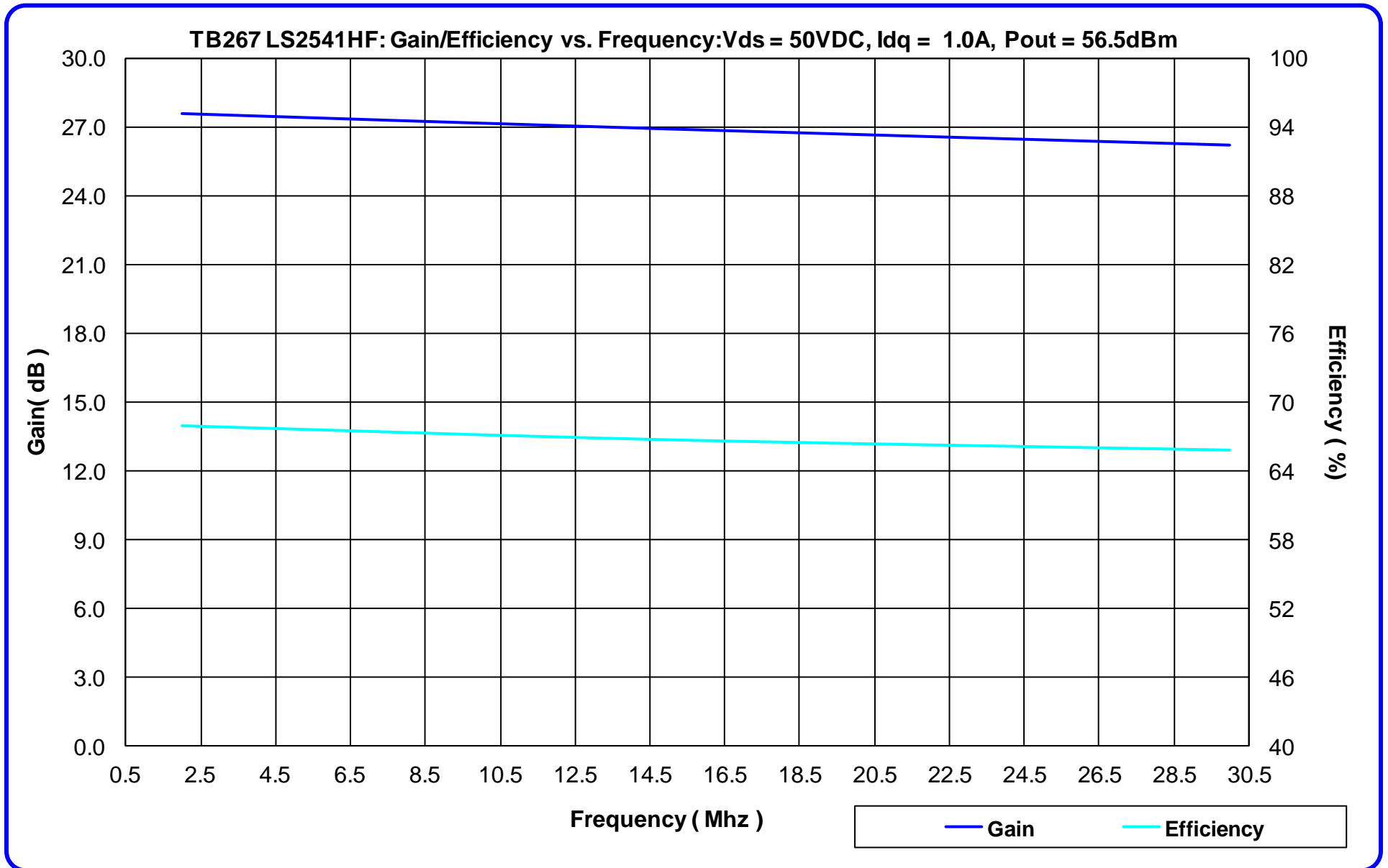

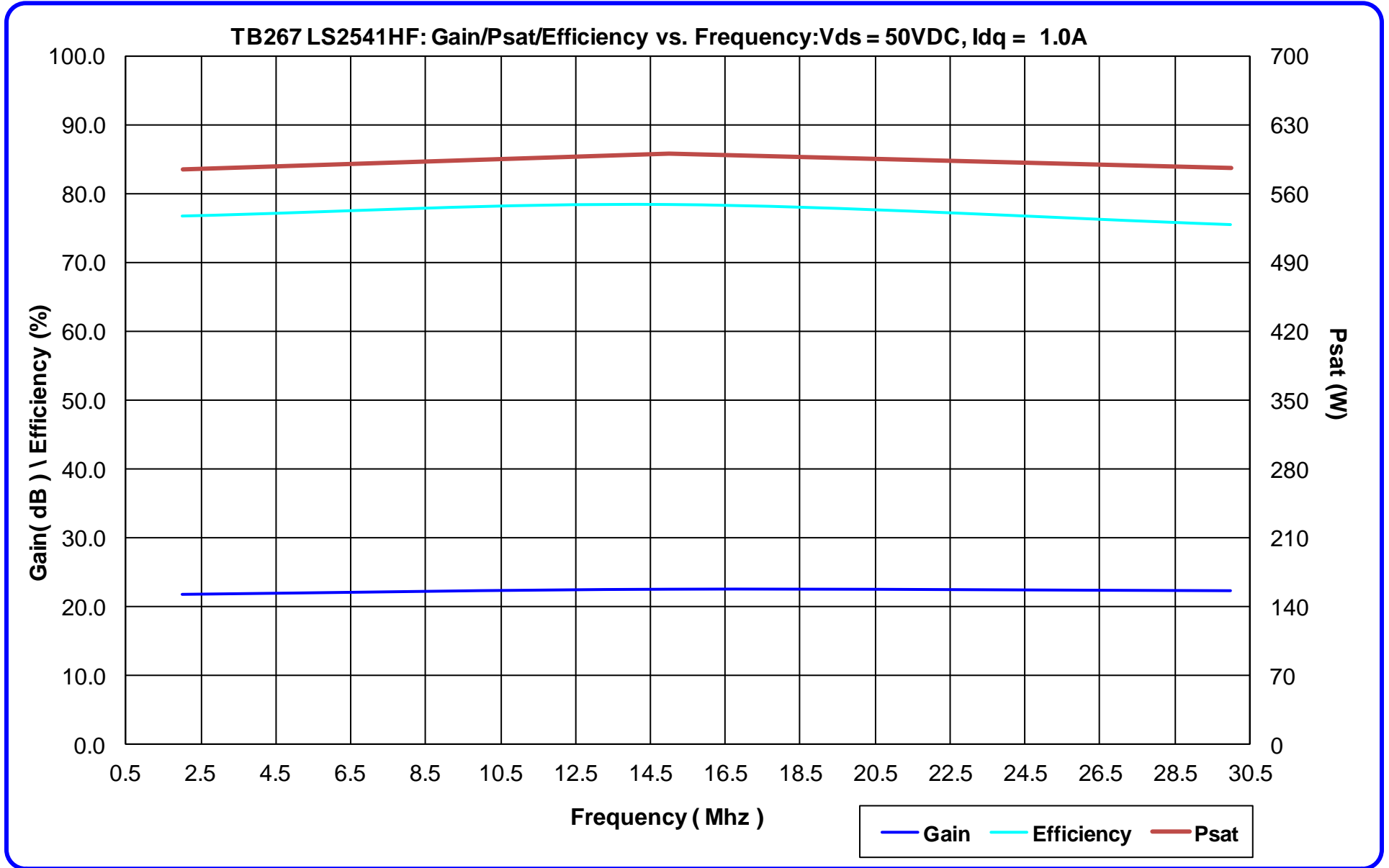

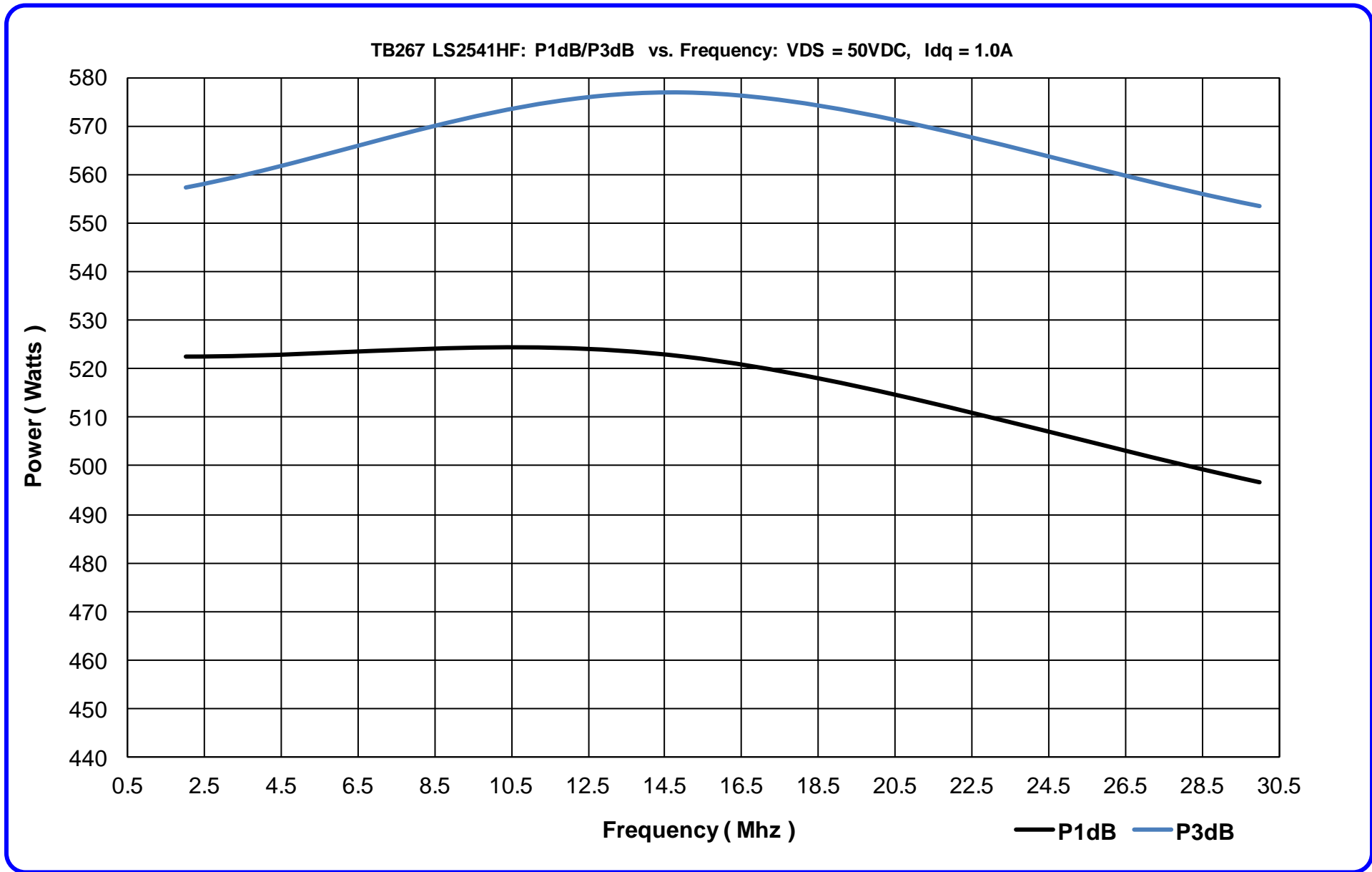

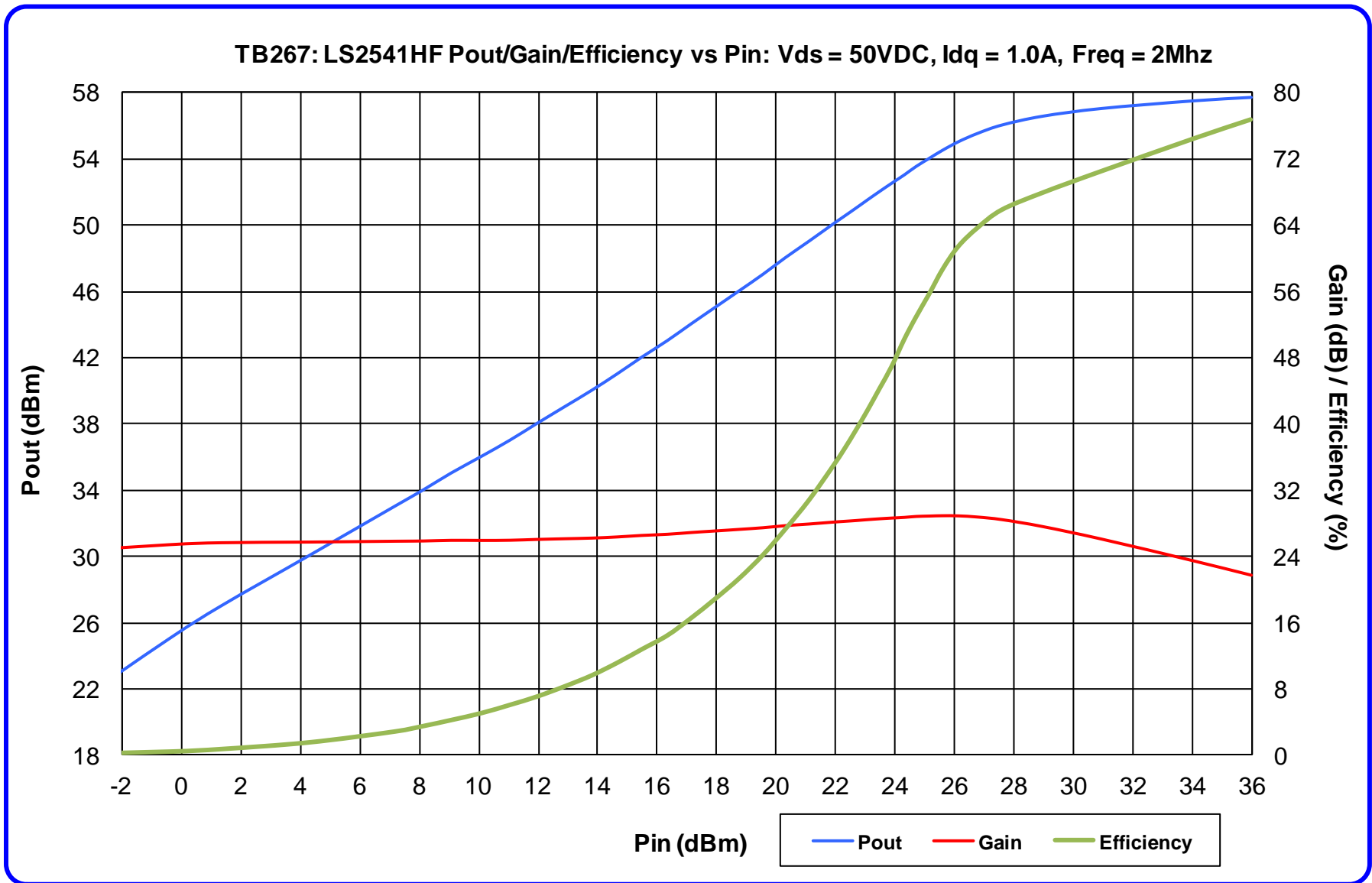

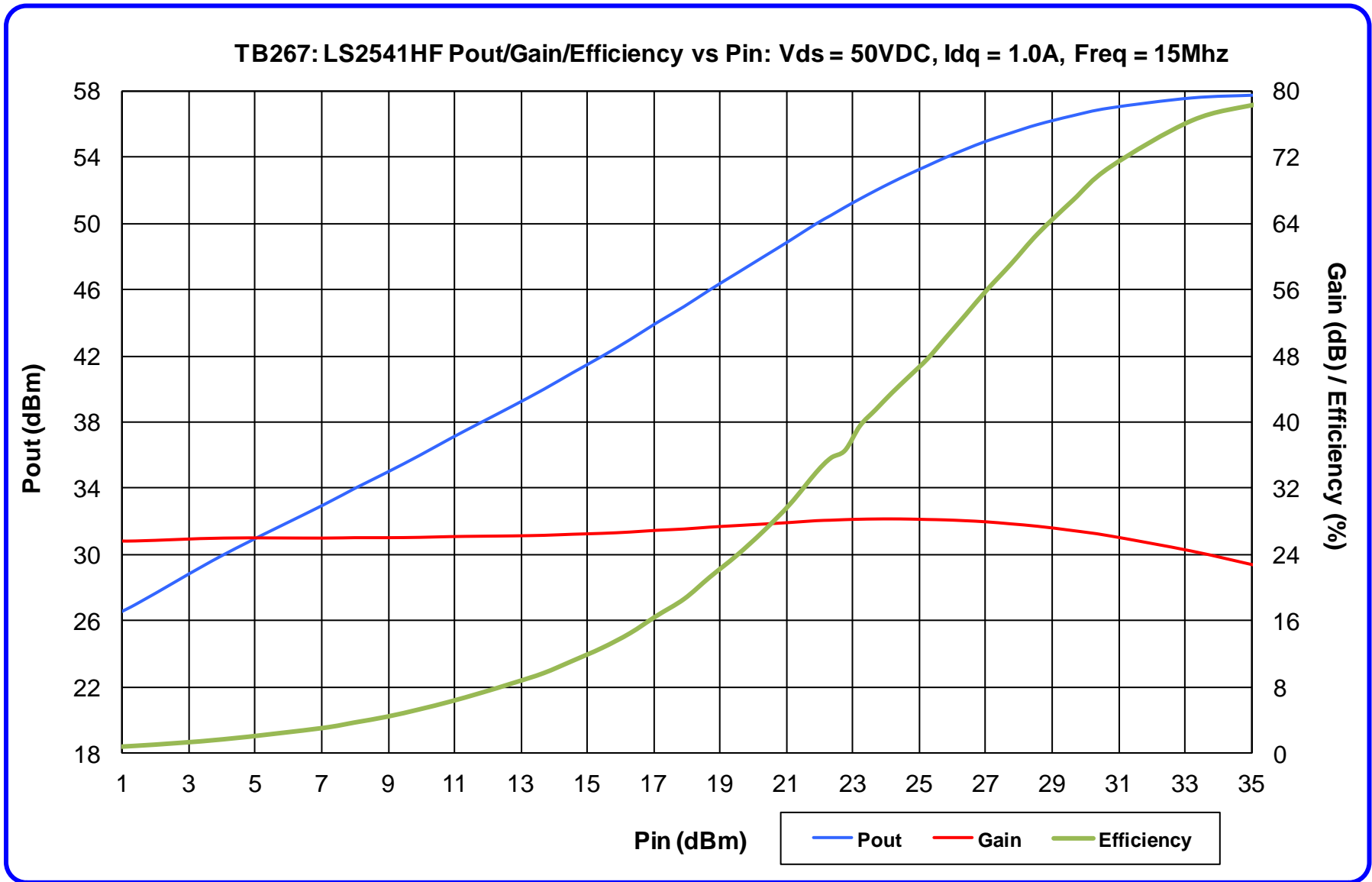

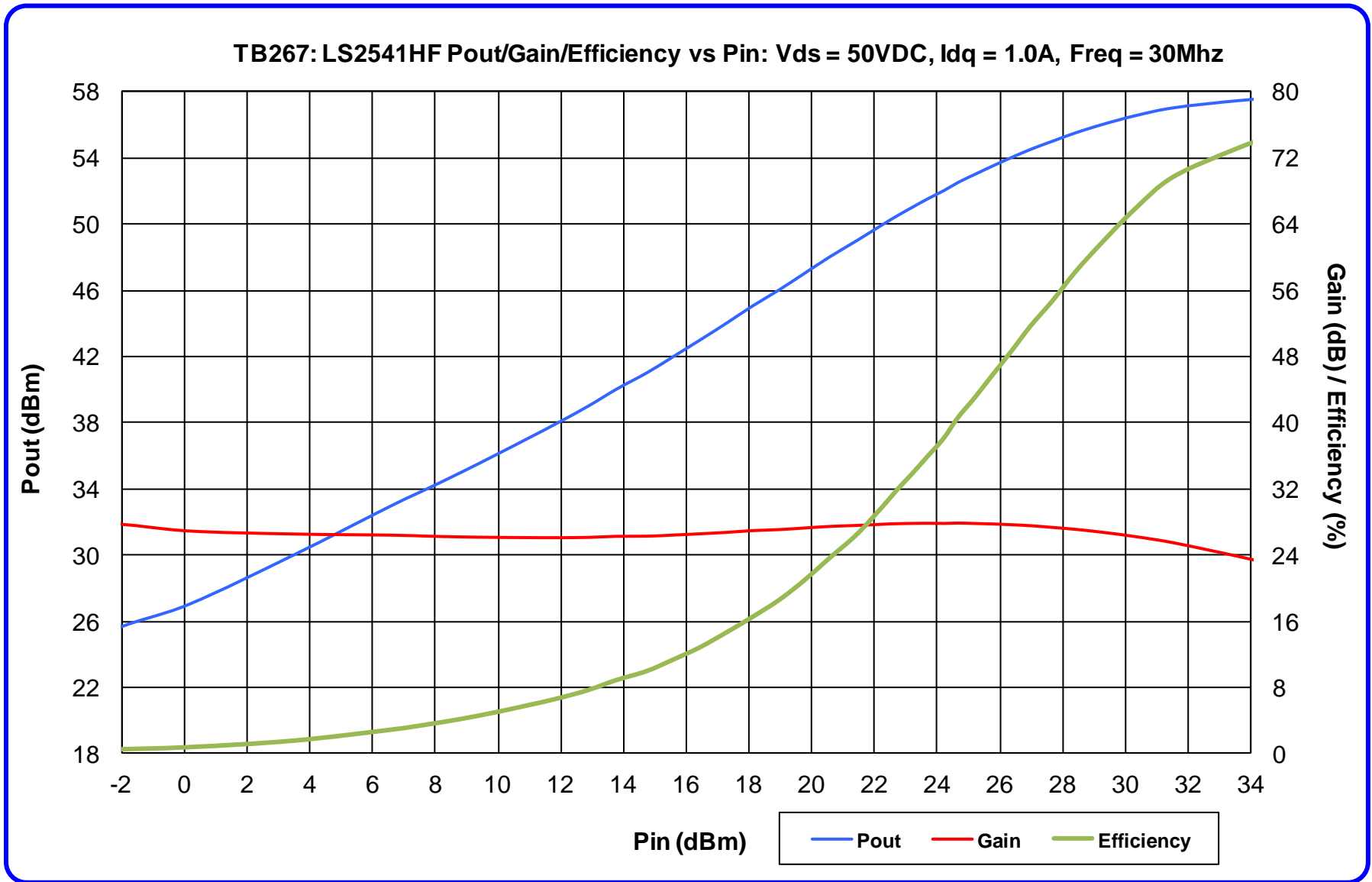

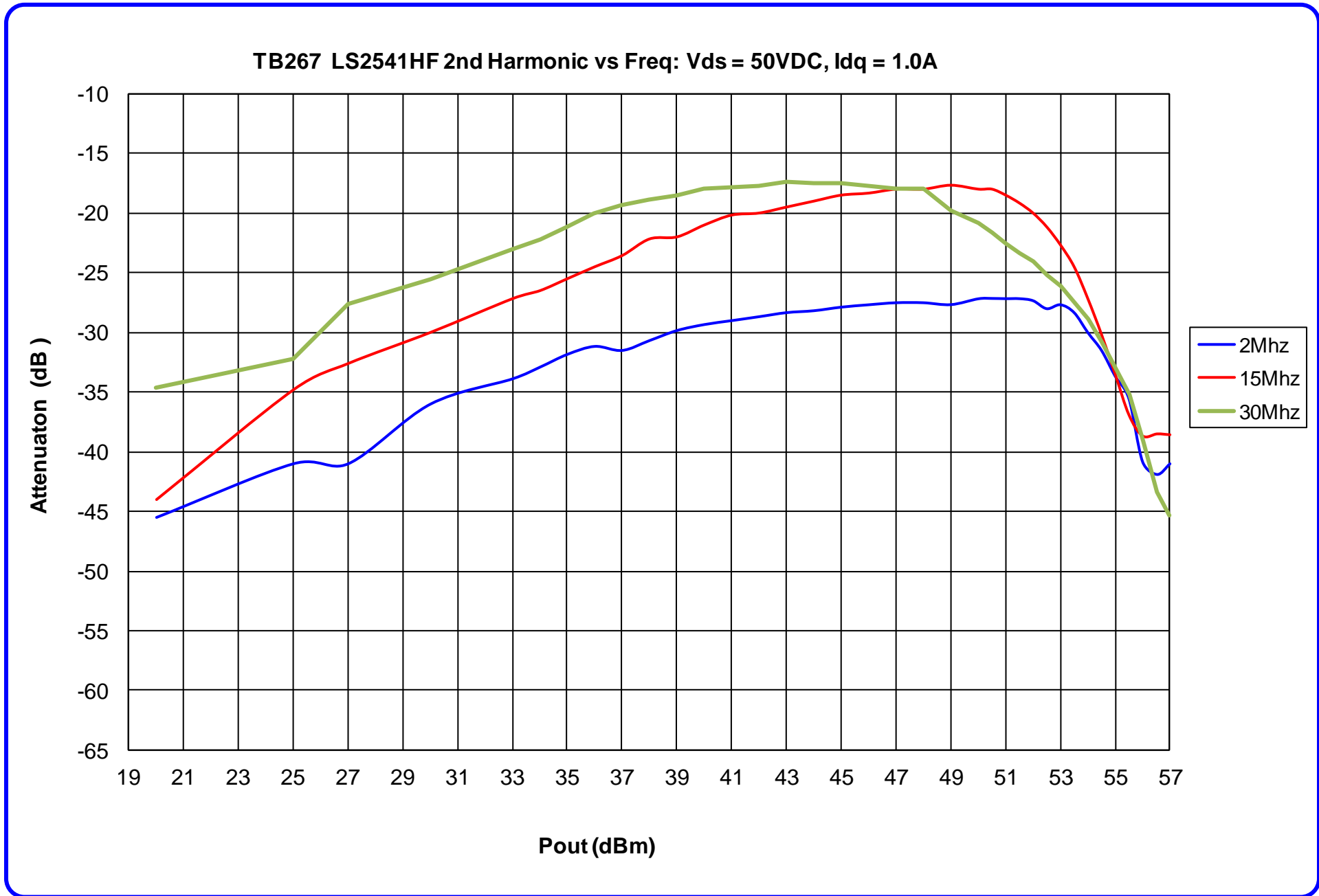



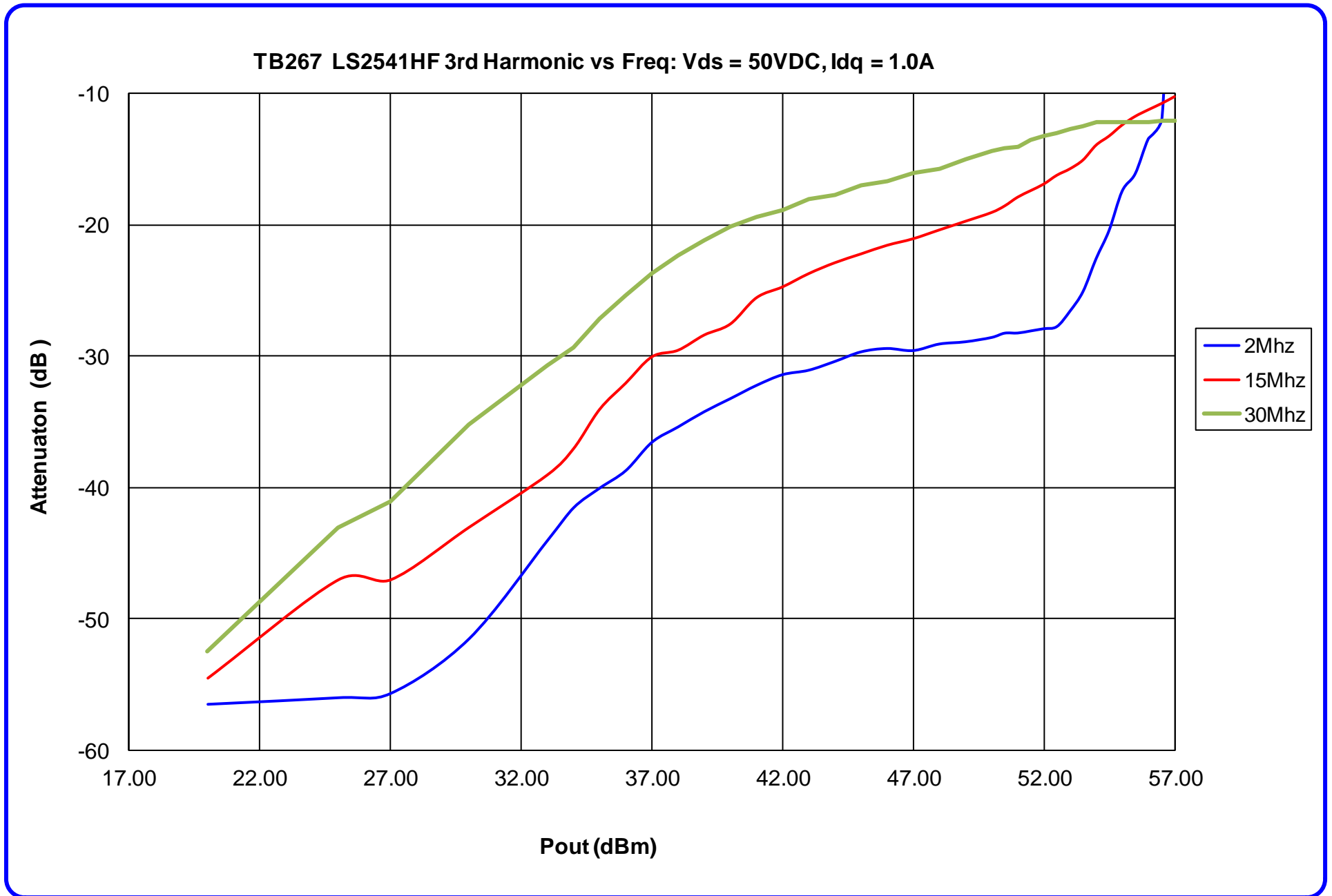

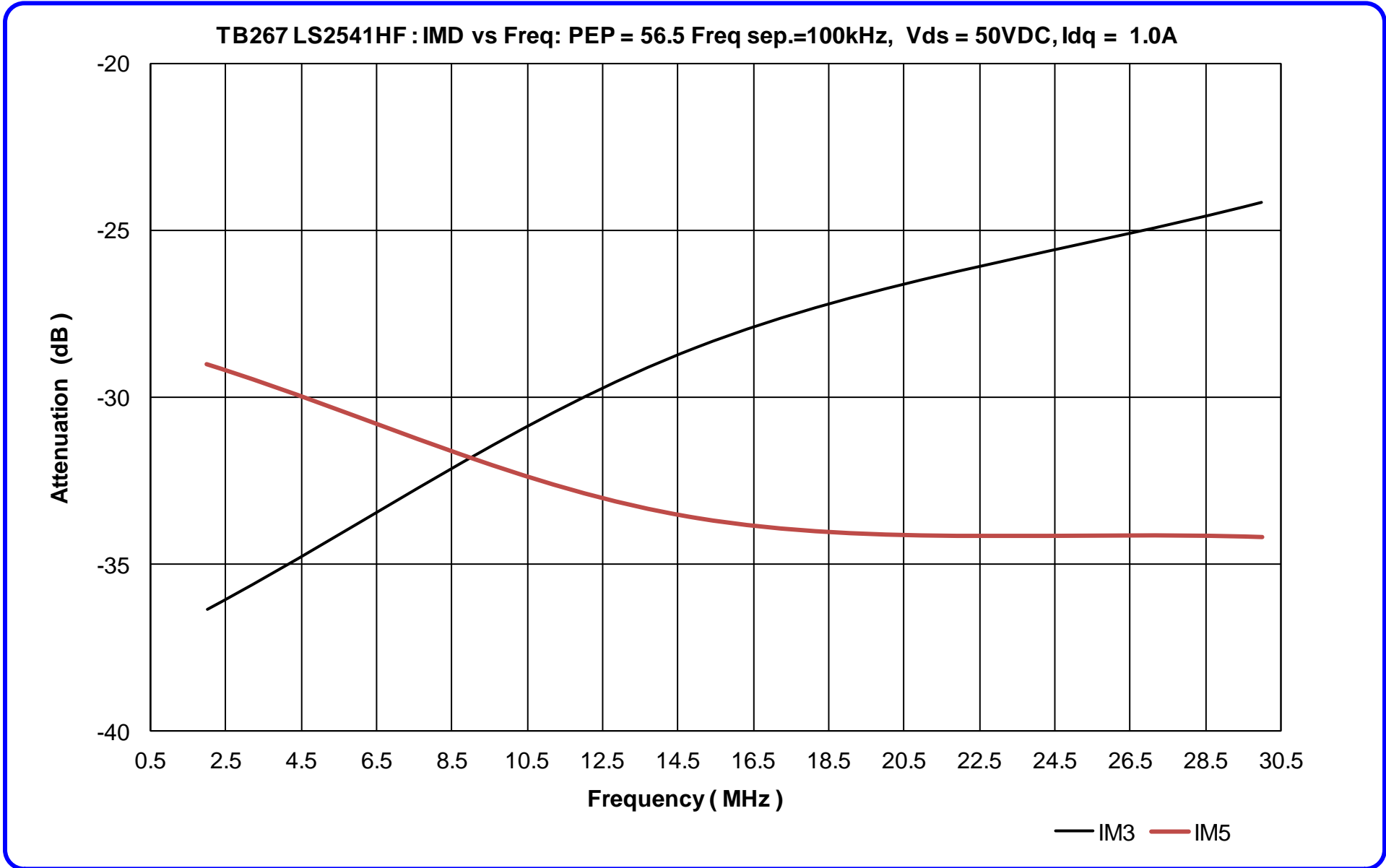

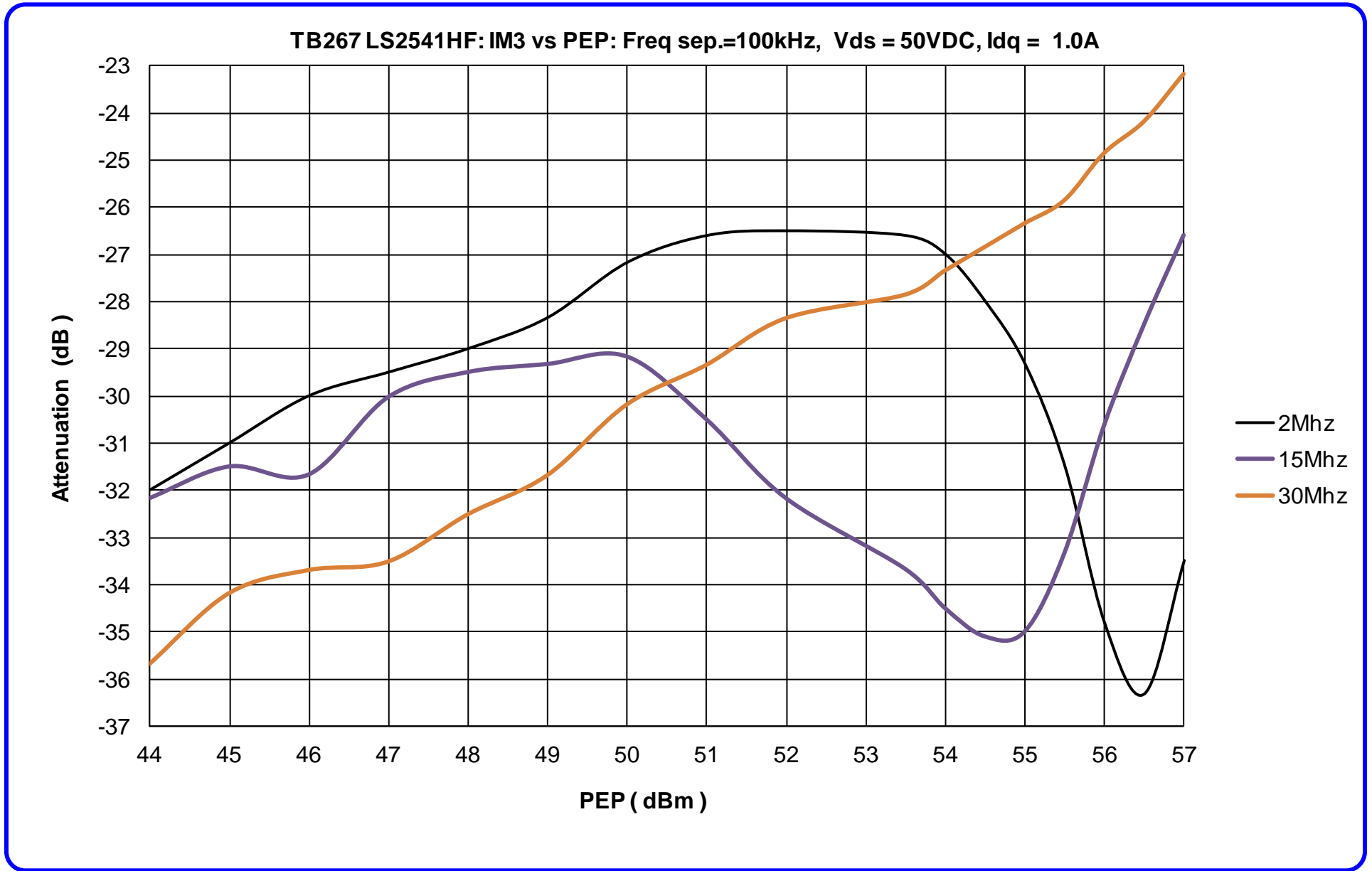

TB267 LS2541HF VDS=50VDC, Idq=1.0A Pin=0dBm

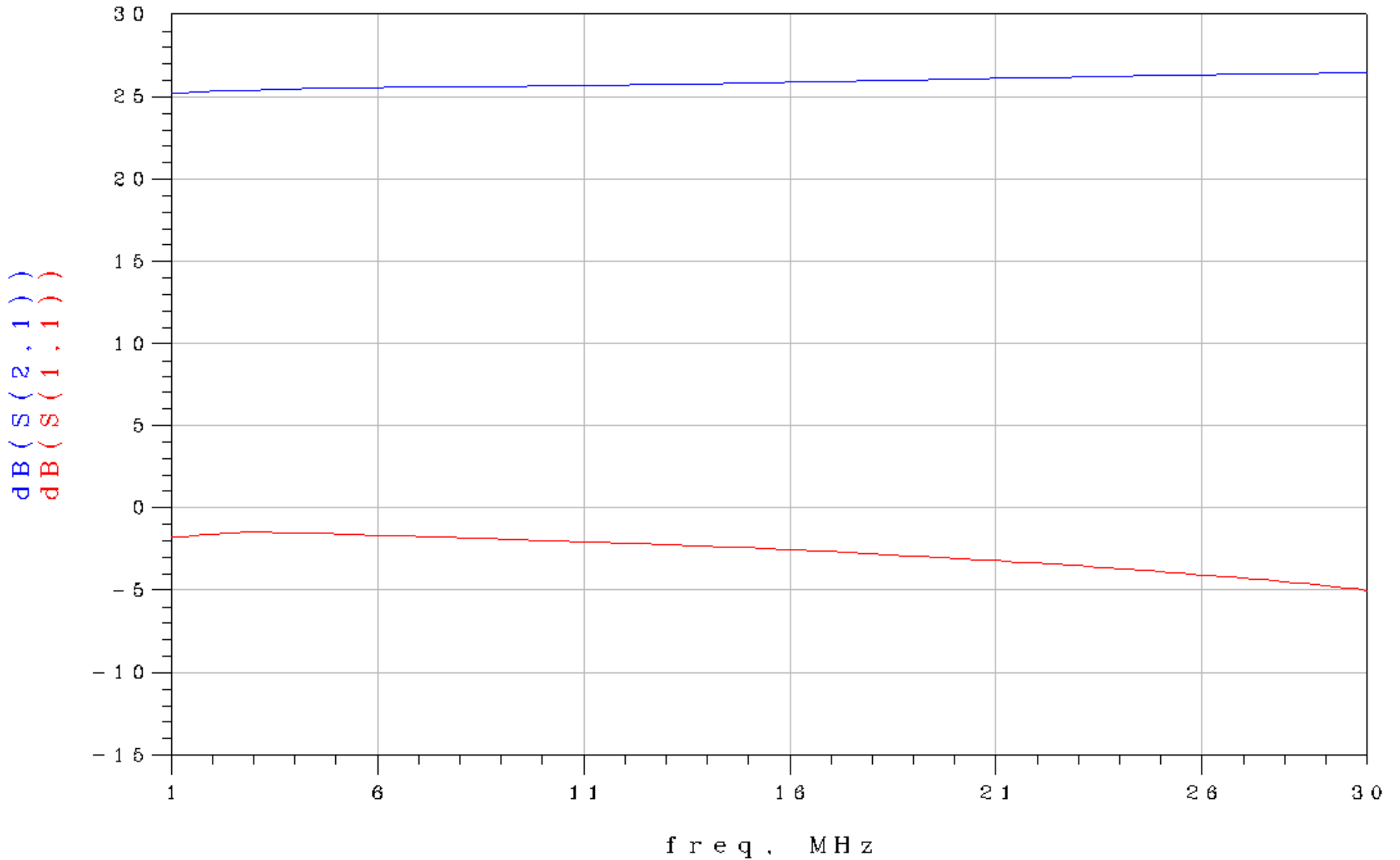

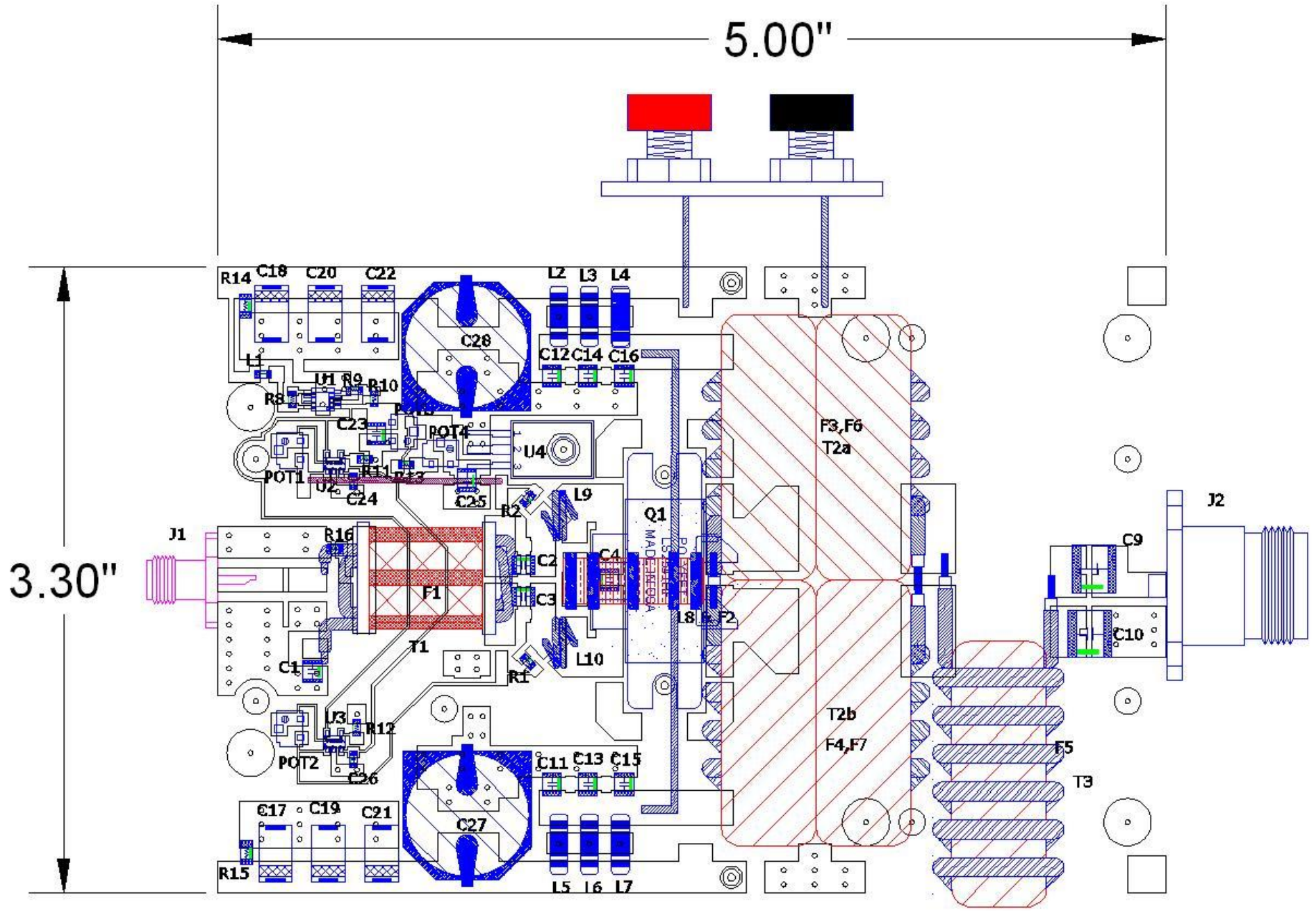

# T1 Materials

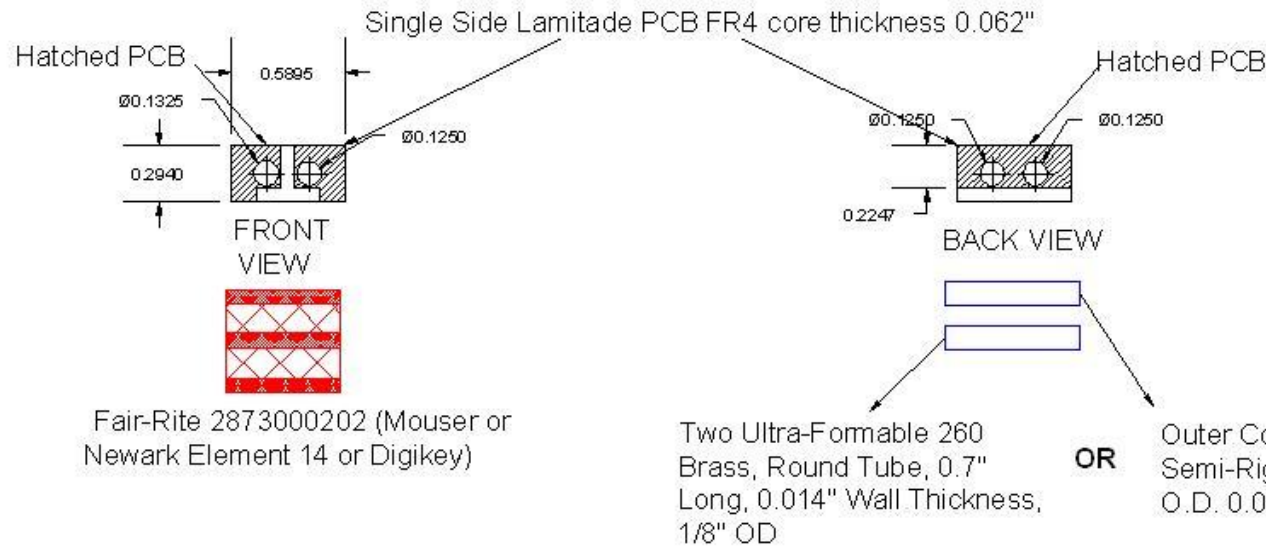

## STEP 1



## STEP 2

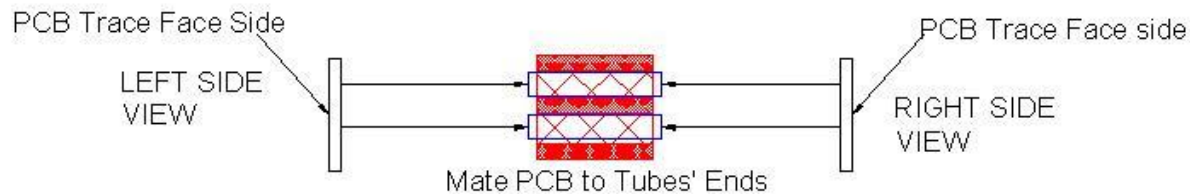

## STEP 3

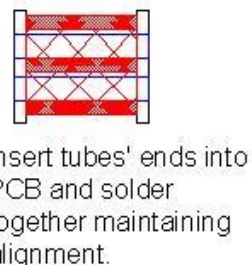

**IMPORTANT:**  
Keep tubes' ends flush with PCB brackets.

## STEP 4

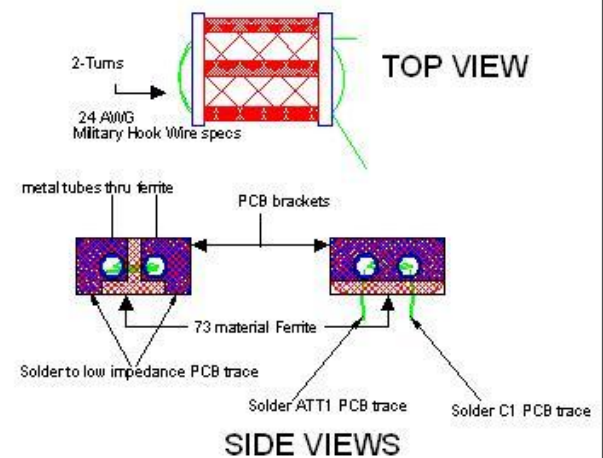

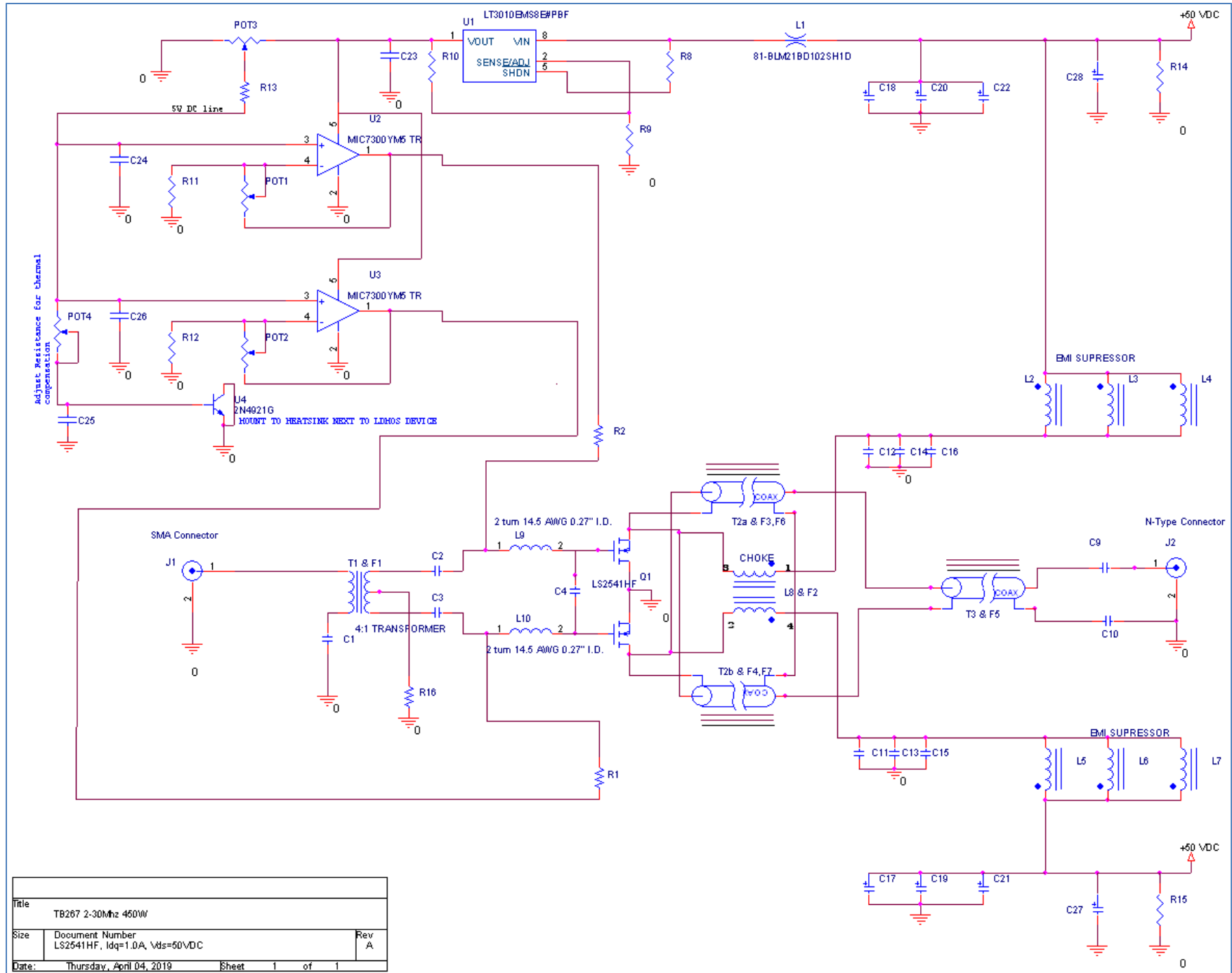

Title		
TB267 2-30MHz 450W		
Size	Document Number	Rev
	LS2541HF, Idq=1.0A, Vds=50VDC	A
Date:	Thursday, April 04, 2019	Sheet 1 of 1



<b>TB267</b>			
<b>NOMENCLATURE</b>	<b>DESCRIPTION</b>	<b>VENDER</b>	<b>VENDER PART #</b>
C1,C2,C3 C15, C16, C23,C30	100,000pF +/-10% RF By-Pass Capacitors,1111X	Passive Plus, Inc	111X104KW500
C4	33pF +/-2% Ultra-low ESR, Microwave Cap., 1111N	Passive Plus, Inc	1111N330GW500
C9,C10	470000pF +/-20% High Q, 150V	Passive Plus, Inc	2225X474MW151X
C11,C13	1000pF +/-2% Ultra-low ESR, Microwave Cap., 1111N	Passive Plus, Inc	1111N102GW500
C12,C14	10,000pF +/-10% RF By-Pass Capacitors,1111X	Passive Plus, Inc	111X103KW500
C17,C18	6.8uF 63V 20% ERS=100Ohms Tantalum Capacitors SMD	AVX	TCJE685M063R0100
C19,C20	10uF 63V 20% ERS=100Ohms Tantalum Capacitors SMD	AVX	TCJE106M063R0100
C21,C22	15uF 63V 20% ERS=150Ohms Tantalum Capacitors SMD	Kemet	T521X156M063ATE150
C24,C26	10uF 10%TAMCERAM HIGH CAP. SMD 805	Johanson Dielectrics	100r15x106kv4e
C27,C28	470uF 80V Panasonic Aluminum Electrolytic Cap. SMD	Panasonic Electronic Components	EEE-TK1K471AM
R1,R2,R8,R9	10K 1/8W 0805 SMD	Rohm Semiconductor	MCR10EZJH103
R10	56K 1/8W 0805 SMD	Rohm Semiconductor	MCR10EZPJ563
R11,R12	2.2K 1/8W 0805 SMD	Rohm Semiconductor	MCR10EZPJ222
R13	390 1/8W 0805 SMD	Rohm Semiconductor	MCR10EZPJ391
R14,R15	RES 10K OHM 1/4W 5% 1206 SMD	Rohm Semiconductor	MCR18EZPJ103
R16	RES 200 OHM 1/4W 5% 1206 SMD	Rohm Semiconductor	MCR18EZPJ201
POT1,POT2,POT3	Trimmer Resistors - 10K OHM 0.25W SMD	Murata Electronics North America	PVG5A103C03R00
POT4	Trimmer Resistors - 100 OHM 0.25W SMD	Murata Electronics North America	PVG5A101C03R00
L1	0805 1kohms HiSpeed EMI Filter Beads,Chokes & Arrays	Murata Electronics North America	81-BLM21BD102SH1D
L2,L3,L4,L5,L6,.L7	EMI/RFI Suppressors & Ferrites 1000pF 100Volts@125C	Tusonix	4700-005LF
L8	Magnetic Wire"W2", Twisted, 6-turns around "F2"	-----	-----
L9,L10	270mil I.D 2 turn aircoil	-----	-----
W1	Military Hook-Wire specs 24awg 19 strand	Allied Wire & Cable, INC	M16878/4BEE9
W2	Magnetic Wire,14.5AWG	www.electromechanicsonline.com	MW145HARD
U1	IC REG LDO ADJ 50mA 8-MSOP	Linear Technology	LT3010EMS8E#PBF
U2,U3	Operational Amplifiers - Op Amps SGL RRIO OP AMP	Texas Instruments	LM7321MF/NOPB
U4	Transistors Bipolar - BJT 3A 40V 30W NPN	ON Semiconductor	2N4921G
F1	Binocular Ferrite 73	Mouser Electronics	2873000202
F2	Toroid Ferrite 43 Material	Amidon	FT-100B-43
F3,F4,F6,F7	77material Toroid	mouser	623-5977002701
F5	Toroid Ferrite 61 Material	Amidon	5961002701
T1	wire "W1" 2 turns around "F1"	-----	-----
T2a,T2b	21 ohm coaxial cable, 9 turns around each ferrite F3 and F4	Belden	83307E-009 - MIL-W-16878/4 (Type E)
T3	50 ohm coaxial cable, 9 turns around F5	Amawave	UT-085C-FORM-F
Q1	LDMOS	Polyfet RF Devices	LS2541HF
J1	PE4000-SF SMA Female; 4 Hole Panel Mount	Pasternack	PE4000-SF
J2	PE4328 N Female; 4 Hole Panel Mount	Pasternack	PE4328
PCB	185HR 0.059", 1oz/1oz er+4.01	Isola	185HR